

WALL & FLOOR

BOOK

2023-2024

MUSEUM

MUSEUM

4. BRAND

10. TECHNOLOGIES

14. ENVIRONMENT

18. COLLECTIONS

316. MUSEUM BATH

332. TECHNICAL INFORMATION



BRAND MARCA

MUSEUM is the premium porcelain and ceramic brand par excellence.

Products conspicuous for their elegance and sophistication, clearly defined by a strong emphasis on innovation and design. Continued investment in cutting-edge technology allows nature to be brought into spaces, creating surfaces that bring wellness and beauty to any project. Working towards a sustainable future, with a real commitment to the environment and to the generations to come.

MUSEUM es la firma cerámica premium por excelencia.

Elegancia y sofisticación definidas por una fuerte apuesta por el diseño y la innovación. La constante inversión en tecnología permite acercar la naturaleza a los espacios, creando superficies que aportan bienestar y belleza a los proyectos. Con un compromiso real con el medioambiente y las generaciones venideras, trabajando para conseguir un futuro más sostenible.

The *future* of tiles is
MUSEUM's *present*



digital tools herramientas digitales

DOWNLOADS DESCARGAS	
<p>HD images of all our settings, patterns and available tiles, plus the files and technical documents for all our products.</p> <p>Todos los ambientes, gráficas y despieces en HD, además de archivos y documentos técnicos de todos nuestros productos.</p>	

INSPIRATION INSPIRACIÓN	
<p>Ideas, creative proposals and product combinations to help with your projects. In addition, a journal with all the news of the brand.</p> <p>Ideas, propuestas y combinaciones de producto para ayudar con sus proyectos. Además, un apartado con la actualidad de la marca.</p>	

MARKETING MARKETING	
<p>A search engine for promotional tools and related downloads: catalogues, sample boards, files and display units.</p> <p>Búsqueda y descarga de herramientas promocionales: catálogos, paneles, carpetas y expositores.</p>	

AUDIOVISUAL AUDIOVISUAL	
<p>Access to all MUSEUM's audiovisual files as videos, miniclips and 360° virtual tours.</p> <p>Acceso a todos los archivos audiovisuales de MUSEUM: videos, miniclips y tours virtuales 360°.</p>	

3D DESIGN DISEÑO 3D	
<p>Setting design and visualizer tools for use on our website.</p> <p>Herramientas para el diseño y renderizado de espacios directamente desde nuestra página web.</p>	

INTRANET INTRANET	
<p>Check our stock in real time, in addition to packing and packaging information.</p> <p>Consulta el stock en tiempo real y la información sobre embalaje y packing.</p>	



1.



NEW KILN INSTALLATION

A great investment that ensures us the productive capacity for the desired growth of the group. With a 245 m length and a 1.500.000 m² production capacity, it gives great versatility, being able to produce large format tables and other traditional press formats.

Una gran inversión que nos asegura la capacidad productiva para el crecimiento deseado del grupo. Con una longitud de 245 m y una capacidad de producción de 1.500.000 m², proporciona una gran versatilidad, pudiendo producir tablas de gran formato y otros formatos de prensa tradicional.

2.



SOLAR PANELS INSTALLATION

17.000 m² of solar panels, which provide an installed power of 2.550.000 kW·h/year.

17.000 m² de placas solares, que puede significar una potencia instalada de 2.550.000 kW·h/año.

3.



NEW LOGISTICS CENTER

New CL2 Logistics Center, which allows us to have twice the covered area, increasing from 20.000 to 43.000 m².

Nuevo Centro Logístico CL2, que nos permite disponer del doble de superficie cubierta, pasando de 20.000 a 43.000 m².

4.



MUSEUM EXPERIENCE SHOWROOM

The MUSEUM showroom has been expanded, with its *MUSEUM experience* area where the most innovative and most valuable product of the brand is shown. Large format for countertops and large paneling boards.

Se ha ampliado la exposición de MUSEUM, con su *área MUSEUM experience* donde se muestra el producto más innovador y de mayor valor de la marca. Gran formato para encimeras y grandes tablas de revestimientos.

TECHNOLOGIES TECNOLOGÍAS

The new MUSEUM range aims to provide exclusivity and differentiation in its products. Thanks to the use of new technology, MUSEUM has broken its own record for excellence, achieving a level of precision and versatility that no other tile range can equal.

La nueva gama de MUSEUM tiene la finalidad de aportar exclusividad y diferenciación en sus productos. Gracias al uso de nuevas tecnologías, MUSEUM ha superado su propio récord de excelencia, logrando un nivel de precisión y versatilidad que ninguna otra gama de cerámica puede igualar.

*Breaking the boundaries
of excellence*





4D TECH

4D TECH is the most innovative tile manufacturing system on the market, based on exclusive new technology aimed at guaranteeing quality second to none. Its innovations are based on the four fundamental pillars of this technology:

Dimension / Design / Definition / Distinction

4D TECH es el sistema de fabricación más innovador del mercado, basado en una tecnología exclusiva cuyo objetivo es garantizar una calidad insuperable. Sus innovaciones se basan en los cuatro pilares fundamentales de dicha tecnología:

Dimensión / Diseño / Definición / Distinción



4D WALL

Our new 4D WALL technology has revolutionized the concept of wall tiles as we know them. Its innovative white-body composition, large 50x150 cm format, and slimline 7.5 mm thickness make the indoor tiling process much simpler and quicker than ever before.

La nueva tecnología 4D WALL transforma el concepto de revestimiento conocido hasta el momento. Su innovadora composición cerámica en pasta blanca, unido al gran formato 50x150 cm y a su fino espesor de 7,5 mm permite simplificar todavía más la logística, manipulación y colocación en interiores.



SHAPED

The new MUSEUM 4D SHAPED technology combines digital and traditional techniques that allows us to coordinate the graphics with the relief to achieve volume on the surface and an extra soft texture that reproduces the natural stone in all its senses.

La nueva tecnología 4D SHAPED de MUSEUM combina tecnología digital y tradicional, que nos permite coordinar la gráfica con el relieve para conseguir volumen en superficie, y una textura extra suave, que reproduce la piedra natural en todos sus sentidos.



20 MM

Our innovative 4D TECH in large 100x100 cm format reaches a 20 mm thickness, to provide us with surfaces of extraordinary resistance for both residential and commercial areas.

Nuestra innovadora tecnología 4D en gran formato 100x100 cm alcanza el espesor de 20 mm, para proporcionarnos superficies de extraordinaria resistencia, tanto para el ámbito residencial como el comercial.



ALL IN ONE

Innovation takes us to a new concept. Now we can use a single surface for several applications both inside and outside a project. Softness and anti-slip are unified to create greater aesthetic continuity in the spaces.

La innovación nos traslada a un nuevo concepto. Ahora podemos utilizar una única superficie para varias aplicaciones, tanto en interior como en exterior. La suavidad y el antideslizamiento se unifican, para crear mayor continuidad estética en los espacios.



DEEP TECH

DEEP TECH technology allows us to maximize the depth of the reliefs obtained to date. This new technology provides a greater definition of the volumes, allowing greater distance between planes within the piece and opens up a universe of decorative possibilities.

La tecnología DEEP TECH nos permite maximizar la profundidad de los relieves obtenidos hasta la fecha. Esta nueva tecnología aporta una mayor definición de los volúmenes, permitiendo mayor distancia entre planos dentro de la pieza y abre un universo de posibilidades decorativas.

ENVIRONMENT MEDIO AMBIENTE



For MUSEUM, an environmental commitment is not a luxury but an absolute necessity. The practices embraced by its work teams and constant investment into technology both play an important part in the fight for a more sustainable, safe future.

As an organization, we have always striven to ensure energy efficiency, lower CO² emissions, the management and re-use of resources, the use of water-based inks, zero-dumping of wastewater, and integrated management of our fully recyclable packaging.

En MUSEUM el compromiso con el medioambiente no es un privilegio, es un requisito. Las prácticas adoptadas por los equipos de trabajo y las constantes inversiones tecnológicas contribuyen en la lucha hacia un futuro más sostenible y seguro.

Como organización hemos potenciado desde un inicio la eficiencia energética, la reducción de emisiones CO², la gestión y reutilización de recursos, la aplicación de tintas en base agua, el vertido cero de aguas residuales y la gestión integrada de los envases 100% reciclables.

54%

Our ceramic tiles contain up to 54% recycled content (ISO 14021). See page 343 for more information.

Nuestras baldosas contienen hasta un 54% de material reciclado (ISO 14021). Consulte la página 343 para más información.

637t

Over the last year, we have setted up solar panels what has allowed us to cut down more than 637 tons of CO² emissions.

En el último año hemos instalado paneles solares que nos han permitido reducir la emisión de 637 toneladas de CO².

5M

We re-use 100% of the unfired clay waste from the production process: 5,208,660 kg of surplus material.

Reutilizamos el 100% del material crudo sobrante del proceso de producción: 5.208.660 kg de material excedente.

100%

All our products are packaged using 100% recycled cardboard. We put on the market over 600.000 kg per year.

Todos nuestros productos están embalados con cartón 100% reciclado. Anualmente ponemos al mercado más de 600.000 kg.





17M

Last year, we recycled 17,012,670 litres of water.





El año pasado reciclamos 17.012.670 litros de agua.

certifications certificados

QUALITY CERTIFICATIONS

	<p>Quality management system in compliance with ISO 9001 norm. Certifies a continuous improvement of processes, products and services, the objective of which is the complete satisfaction of all our involved parties.</p>	<p>Sistema de gestión de la calidad basado en la norma internacional ISO 9001. Certifica la mejora continua de todos los procesos, productos y servicios de la organización con el objetivo de aumentar la satisfacción de todas nuestras partes interesadas.</p>
	<p>This declares that our products comply with the stipulations of the CE marking, under which a product must be assessed before it is put on sale and comply with the applicable health, safety and environmental requirements.</p>	<p>Declara la conformidad de nuestros productos con los requisitos establecidos en el mercado CE que establece que un producto es evaluado antes de ser introducido en el mercado y que cumple con los requisitos de seguridad, salud y protección medioambiental aplicables.</p>
	<p>The CCC certificate is compulsory for products exported to China. It guarantees that products with a low water absorption rate (E<0.5%) comply with the safety and quality requirements.</p>	<p>El certificado CCC es un sistema de certificación obligatorio para las exportaciones a China que garantiza que los productos con baja absorción de agua (E<0.5%) cumplen con los requisitos de seguridad y calidad establecidos.</p>
	<p>This is a product approval certificate, issued by the French Institute CSTB, who verifies the technical suitability of top quality products in relation to the type of use intended.</p>	<p>Es una certificación de aprobación de productos, emitido por el Instituto Francés CSTB, y verifica la idoneidad técnica de productos de primera calidad en relación al tipo de uso destinados.</p>
	<p>The Saudi Quality Mark (SQM) is a quality mark regulated by SASO (Saudi Standards, Metrology, and Quality Organization) in order to conduct exports to the country.</p>	<p>La Saudi Quality Mark (SQM) es una marca de calidad regulada por SASO (Organización Saudita de Estándares, Metrología y Calidad) para poder realizar exportaciones al país.</p>

SUSTAINABILITY CERTIFICATIONS

	<p>An Environmental Product Declaration in compliance with the UNE-EN ISO 14025 standard, which provides environmental info based on the lifecycle of our products.</p>	<p>Es una Declaración Ambiental de Producto de conformidad con la Norma UNE-EN ISO 14025, que proporciona información medioambiental basada en el ciclo de vida de nuestros productos.</p>
	<p>An environmental label for the french market, which provides information on the VOC content (volatile organic compounds). It declares that our products are rated A+, contributing to a healthy environmentally-friendly habitat.</p>	<p>Etiqueta medioambiental para el mercado francés que informa sobre el contenido en COV's (compuestos orgánicos volátiles). Declara que nuestros productos son A+, contribuyendo a un hábitat sano y respetuoso con el medioambiente.</p>
	<p>A sustainable building certification system developed by U.S. Green Building Council®. Our products can contribute to obtain points for LEED certification.</p>	<p>Sistema de certificación de edificios sostenibles desarrollado por U.S. Green Building Council®. Nuestros productos pueden contribuir a obtener puntos para la certificación LEED.</p>
	<p>A sustainable building certification system developed by Building Research Establishment. Our products can contribute to obtain points for BREEAM® certification.</p>	<p>Sistema de certificación de edificios sostenibles desarrollado por Building Research Establishment. Nuestros productos pueden contribuir a obtener puntos para la certificación BREEAM®.</p>

COLLECTIONS COLECCIONES

18 *marble effect* *efecto mármol*

arte
calacatta 4D
crystal
dual
haute
lumina
marquina
onix
opera
orobico
praliné
premiere
statuario plus
sublime ⁽³⁾
supreme
torano

6 *stone effect* *efecto piedra*













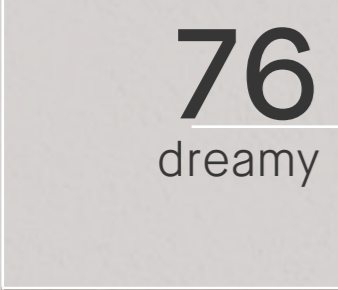
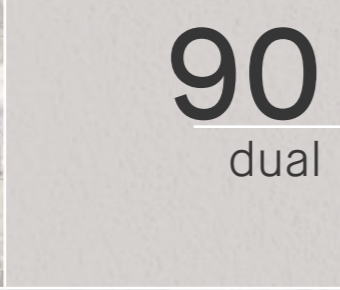
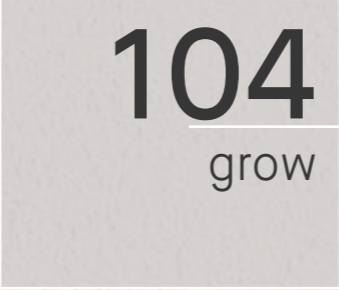
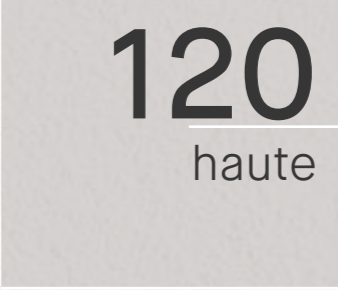

chicago
dreamy
kron 4D
lakestone
mainstone
strönd
sublime ⁽¹⁾

1 *metal effect* *efecto metal*

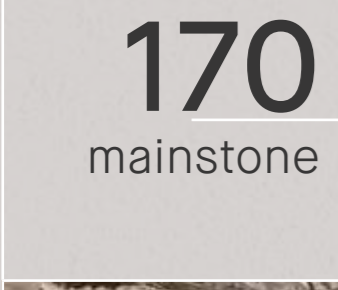
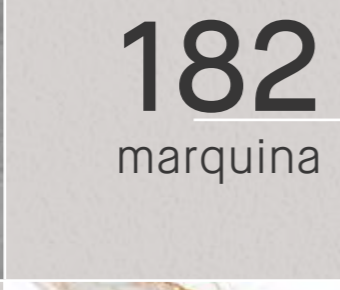
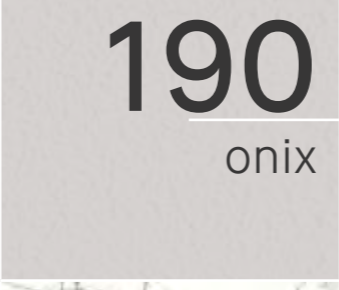
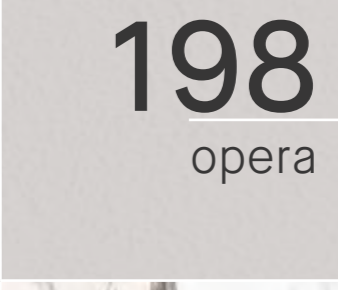
iron 4D

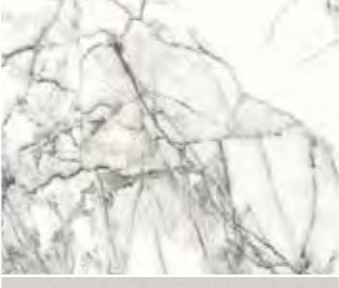
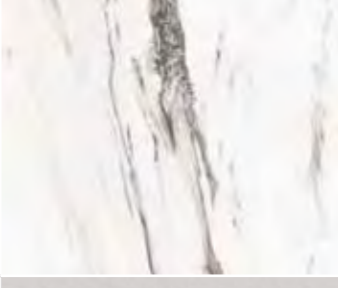
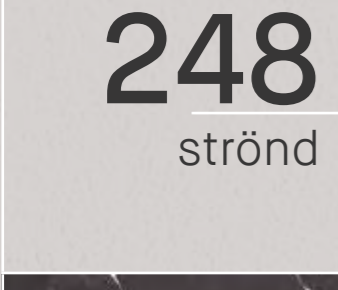
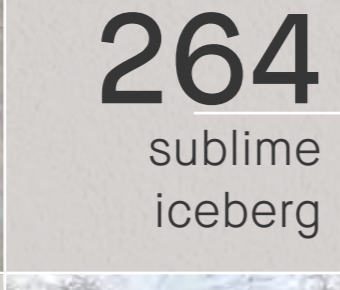
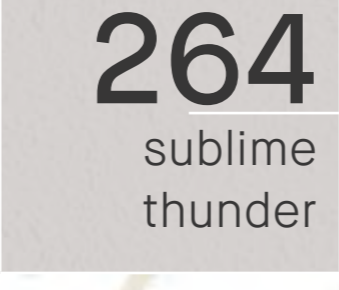
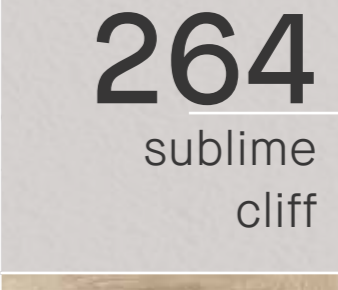
2 *wood effect* *efecto madera*

grow
wistman oak

	26 arte		40 calacatta 4D		50 chicago		66 crystal
	76 dreamy		90 dual		104 grow		120 haute
	134 iron 4D		142 kron 4D		150 lakestone		162 lumina
	170 mainstone		182 marquina		190 onix		198 opera
	206 orobico		216 praliné		230 premiere		240 statuario plus
	248 strönd		264 sublime iceberg		264 sublime thunder		264 sublime cliff
	264 sublime vulcano		282 supreme		296 torano		306 wistman oak



PREMIUM POLISHED (P)	
Polished crystal mirror finish with a perfect reflection.	
Acabado pulido con un perfecto reflejo especular.	



POLISHED (EP)	
Polished smooth finish with a deep reflection.	
Acabado liso pulido con un profundo reflejo.	



SHAPED (SP)	
Smooth texture, graphic perfectly coordinated with the relief.	
Textura suave, perfecta coordinación entre gráfica y relieve.	



NATURAL (NT)	
Smooth and soft touch, a matte texture ideal for residential use.	
Tacto suave y liso, textura mate ideal para uso residencial.	



ALL IN ONE (AS)	
Unique surface perfect for both indoor and outdoor spaces.	
Superficie única perfecta tanto para espacios de interior como de exterior.	



ANTISLIP (A)	
Textured surface with matte finish, recommended for outdoor use and wet areas.	
Superficie texturizada mate, recomendada para uso exterior y zonas húmedas.	

PORCELAIN PORCELÁNICO

10 mm

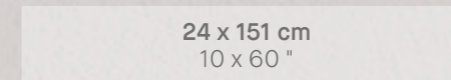
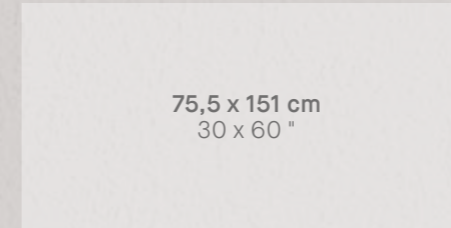

WHITE BODY PASTA BLANCA

10'5 / 13,5 mm

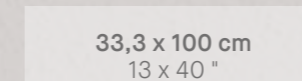

PORCELAIN 4D PORCELÁNICO 4D

6 mm



8 mm



8 / 20 mm







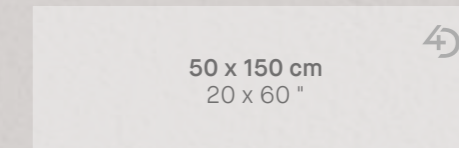

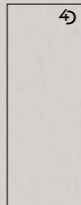
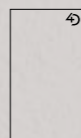

WHITE BODY 4D PASTA BLANCA 4D

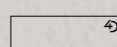
7'5 mm

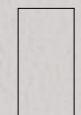

Slight shade variations may exist across formats and depending on the manufacturing process applied to each finish. Puede haber ligeras variaciones de tono en función del formato y el proceso de fabricación aplicado a cada acabado.

Collection	Page	 100 x 275 40 x 109"	 100 x 180 40 x 71"	 100 x 100 40 x 40"	 50 x 100 20 x 40"	 50 x 150 20 x 60" <small>WHITE BODY 4D</small>
ARTE	26	SP	SP	SP - A	A	SP
CALACATTA 4D	40	P - NT	P - NT	P - NT		
CHICAGO	50	SP	SP	SP - A	A	SP
CRYSTAL	66					
DREAMY	76		SP	SP		
DUAL	90	SP	P - SP	SP		
GROW	104					
HAUTE	120	SP	SP	SP		
IRON 4D	134		SP	SP		
KRON 4D	142	NT				
LAKESTONE	150					
LUMINA	162					
MAINSTONE	170					
MARQUINA	182					
ONIX	190					
OPERA	198					
OROBICO	206					
PRALINÉ	216	SP	P - SP	SP		
PREMIERE	230	SP	P - SP	SP		
STATUARIO PLUS	240					
STRÖND	248	SP	SP	SP - A	A	
SUBLIME	264	P - SP	SP	SP		
SUPREME	282	SP	P - SP	SP		
TORANO	296					
WISTMAN OAK	306					

	 24 x 151 10 x 60"	 75,5 x 151 30 x 60"	 60 x 120 24 x 48"	 90 x 90 cm 36 x 36"	 33,3 x 100 13 x 40" <small>WHITE BODY</small>	Page	Collection
		EP - AS	AS			26	ARTE
						40	CALACATTA 4D
			NT	NT - A		50	CHICAGO
		EP	EP			66	CRYSTAL
		EP	EP - AS			76	DREAMY
		EP - NT	EP - NT		SP	90	DUAL
SP					SP	104	GROW
		SP - EP	SP - EP		SP	120	HAUTE
						134	IRON 4D
						142	KRON 4D
			AS	AS	NT	150	LAKESTONE
		EP	EP			162	LUMINA
		NT	NT	NT - A		170	MAINSTONE
		EP	EP			182	MARQUINA
		EP	EP			190	ONIX
		EP	EP			198	OPERA
		EP	EP			206	OROBICO
		EP - NT	EP - NT		SP	216	PRALINÉ
		SP - EP	SP - EP			230	PREMIERE
		EP	EP			240	STATUARIO PLUS
			SP	SP - A		248	STRÖND
		EP - NT	EP - NT		SP	264	SUBLIME
		EP - NT	EP - NT			282	SUPREME
		EP - NT	EP - NT	EP - NT		296	TORANO
				NT		306	WISTMAN OAK

ARTE

Inspired by *Travertine* marble, ARTE emulates the porous limestone used for centuries in the worlds of building and architecture. Its longitudinal veins are enriched by their different intermingling shades of colour, bringing a warm, restful feel to settings.

ARTE comes in a choice of three different colours —Cloud, Desert and Mocha— in a 100x275 cm, 100x180 cm, 100x100 cm, 75.5x151 cm or 60x120 cm format, together with a 50x150 cm 4D WALL tile model. The collection also features a choice of a Shaped, Polished and All in One finish, in addition to a 20 mm-thick non-slip outdoor model in 100x100 cm and 50x100 cm formats.

Inspirada en el mármol *Travertino*, la colección ARTE representa una piedra caliza porosa utilizada durante siglos en el mundo de la construcción y la arquitectura. Su veteado longitudinal se enriquece de diferentes tonalidades que se entremezclan entre sí, contribuyendo a crear estancias cálidas, donde la calma y la serenidad pasan a ser las protagonistas.

Disponible en tres tonalidades diferentes —Cloud, Desert y Mocha— en los formatos 100x275 cm, 100x180 cm, 100x100 cm, 75.5x151 cm, 60x120 cm, y revestimiento 4D WALL en 50x150 cm. En una gran variedad de acabados como son Shaped, Polished, All in one, y acompañado de la solución de exterior Antislip en 20 mm en los formatos 100x100 cm y 50x100 cm.

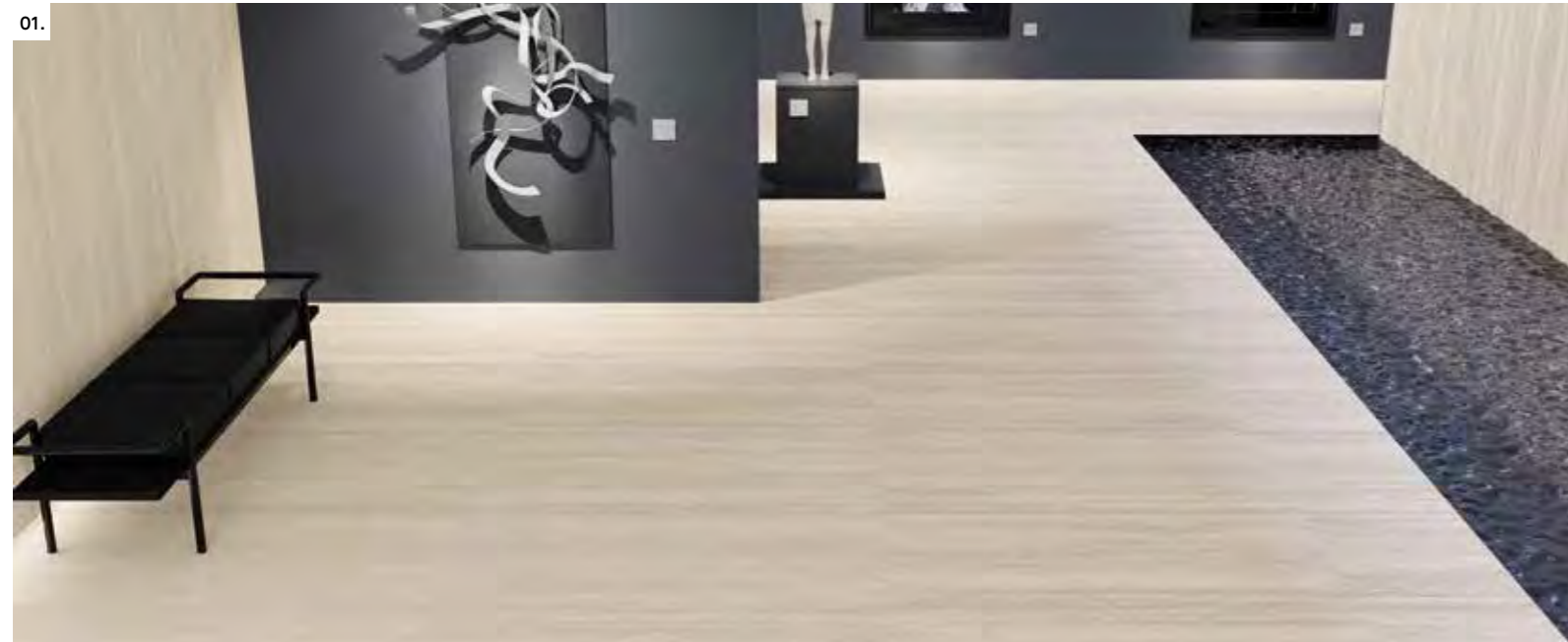

COLOURS

CLOUD



DESERT



MOCHA



FINISHES



FORMATS

150x320 cm available (ELEVATE WORKTOPS).
Disponible 150x320 cm (ELEVATE WORKTOPS).

Special Pieces Piezas Especiales

D. MOSAIC

30x30 cm
11.8x11.8"

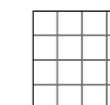

D. MIX

30x30 cm
11.8x11.8"

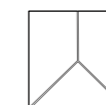

D. GEO

White Body
25x25 cm
9.8x9.8"



D. HORIZON

30x60 cm
11.8x23.6"

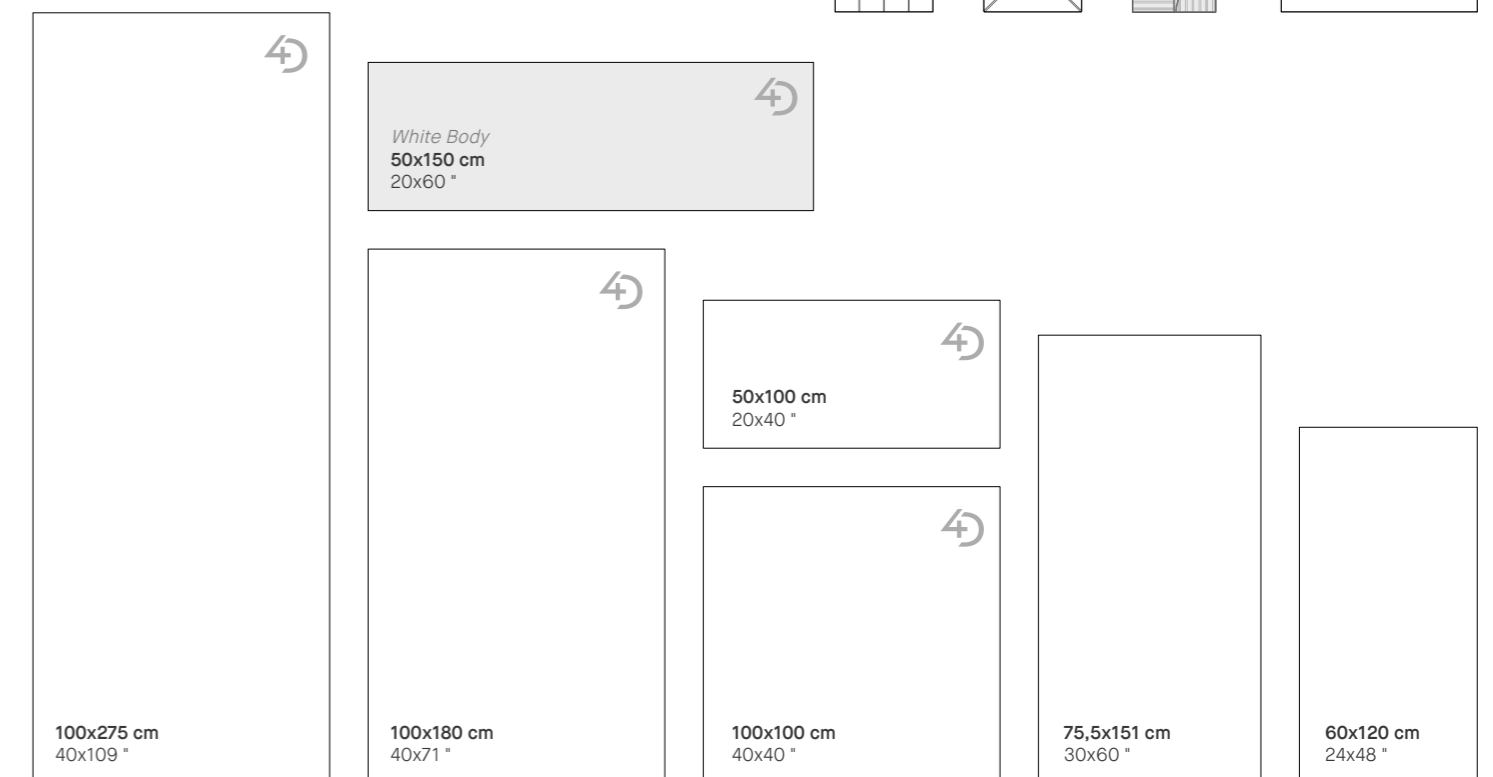
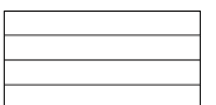

- 01. ■ & ■ ARTE DESERT SP/100X180/R
- 02. ■ ARTE CLOUD SP/100X100X2/R ■ ARTE CLOUD SP/100X275/R
- 03. ARTE DESERT SP
- 04. ■ D. ARTE MOCHA HORIZON 30X60
- 05. ARTE CLOUD close-up.

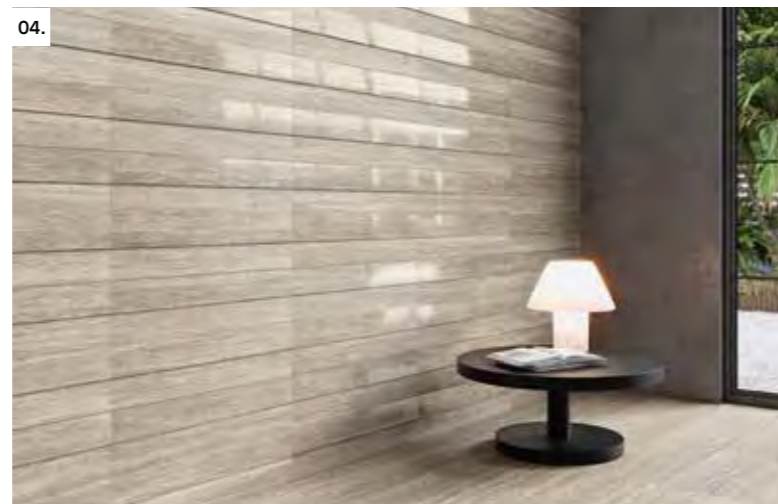

Scan and discover ARTE:
Escanee y descubra ARTE:





07.



- 06. ■ ARTE CLOUD 75,5X151/EP & PL. ARTE CLOUD/30X75,5/18/EP
- 07. ■ ARTE DESERT SP/50X150 & ARTE DESERT DECOR SP/50X150 ■ ARTE DESERT AS/60X120/C/R
- 08. ■ ARTE DESERT DECOR SP/50X150

08.







PATTERNS VARIETY VARIEDAD GRÁFICA ARTE MOCHA 60x120 cm FORMAT ARTE MOCHA FORMATO 60x120 cm

FORMATS FORMATOS



		Porcelain Porcelánico				White Body Pasta Blanca			
		100x275 cm 40x109"	100x180 cm 40x71"	100x100 cm 40x40"	50x100 cm 20x40"	75,5x151 cm 30x60"	60x120 cm 24x48"	50x150 cm 20x60"	50x150 cm 20x60" DECOR
Thickness Espesor		6 mm	8 mm / 20 mm*		20 mm	10 mm		7,5 mm	
Patterns Gráficas		5	9	15	30	15	20	20	20
CLOUD	Shaped (SP)	34683 M90	34710 M94	34702 M93	-	-	-	34698 M105	34699 M106
	Antislip (A)	-	-	34705* M113	35564 M115	-	-	-	-
	Polished (EP)	-	-	-	-	34695 M58	-	-	-
	All in One (AS)	-	-	-	-	34692 M92	34689 M91	-	-
DESERT	Shaped (SP)	34682 M90	34712 M94	34703 M93	-	-	-	34700 M105	34701 M106
	Antislip (A)	-	-	34706* M113	35566 M115	-	-	-	-
	Polished (EP)	-	-	-	-	34694 M58	-	-	-
	All in One (AS)	-	-	-	-	34691 M92	31688 M91	-	-
MOCHA	Shaped (SP)	34684 M90	34711 M94	34704 M93	-	-	-	-	-
	Antislip (A)	-	-	34707* M113	35565 M115	-	-	-	-
	Polished (EP)	-	-	-	-	34696 M58	-	-	-
	All in One (AS)	-	-	-	-	34693 M92	34690 M91	-	-

TECHNICAL DATA DATOS TÉCNICOS



	DIN 51130	DIN 51097	UNE-41901 EX	BS 7976-2 (PTV)	ANSI A137.1 (DCOF)
Shaped (SP)	-	-	Class 1	-	>0,42
Antislip (A)	R11	A + B + C	Class 3	+36 Wet	>0,42
All in One (AS)	R11	A + B + C	Class 3	+36 Wet	>0,42

SPECIAL PIECES PIEZAS ESPECIALES



Porcelain Porcelánico (10 mm)

D. MOSAIC 30x30 cm 11.8x11.8 "			
	CLOUD	All in One (AS)	34885 U36
	DESERT	All in One (AS)	34886 U36
	MOCHA	All in One (AS)	34887 U36

White Body Pasta Blanca (7,5 mm)

*** D. GEO 25x25 cm 9.8x9.8 "			
	CLOUD	Shaped (SP)	34883 U58
	DESERT	Shaped (SP)	34884 U58

Porcelain Porcelánico (10 mm)

* D. HORIZON 30x60 cm 11.8x23.6 "			
	CLOUD	Polished (EP) All in One (AS)	34896 U66
	DESERT	Polished (EP) All in One (AS)	34902 U66
	MOCHA	Polished (EP) All in One (AS)	34903 U66

* D. HORIZON combines cuts with different heights: low pieces (AS) are 10 mm and high ones are elevated to 13 mm (EP).
* D. HORIZON combina cortes a distintas alturas: las piezas bajas (AS) son 10 mm y las altas (EP) se elevan hasta los 13 mm.

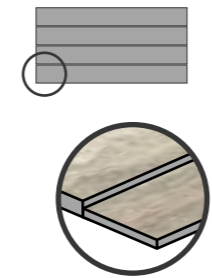

** Only suitable for wall installations.
** Adecuado únicamente como revestimiento.

*** Random colour position.
*** Posición de colores aleatoria.

POOL PIECES PIEZAS DE PISCINA

10 mm

Porcelain Porcelánico

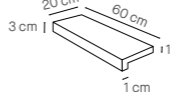
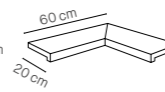
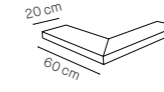
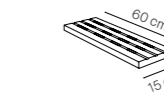
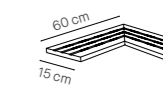
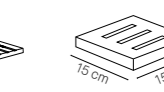
					
P.V. (POOL COPING)	ANG.P.V. (POOL COPING INTERNAL CORNER)	E.P.V. (POOL COPING EXTERNAL CORNER)	REJ. (DRAINAGE GRATE)	ANG.REJ. (ANGLE CORNER DRAINAGE GRATE)	T.REJ. (SQUARE CORNER DRAINAGE GRATE)
20x60x1 cm 8x23.6x0.4 "	60x60x1 cm 23.6x23.6x0.4 "	60x60x1 cm 23.6x23.6x0.4 "	15x60x2,3 cm 6x23.6x0.9 "	60x60x2,3 cm 23.6x23.6x0.9 "	15x15x2,3 cm 6x6x0.9 "

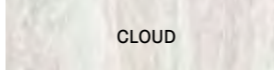
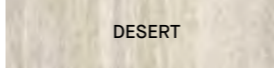
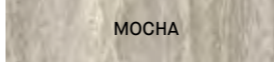
	CLOUD	All in One (AS)	35476 U61	35483 U70	35487 U70	35493 U54	35496 U75	35499 U71
	DESERT	All in One (AS)	35477 U61	35485 U70	35488 U70	35494 U54	35497 U75	35500 U71
	MOCHA	All in One (AS)	35478 U61	35486 U70	35490 U70	35495 U54	35498 U75	35501 U71

20 mm

Porcelain Porcelánico

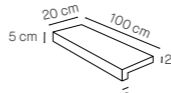
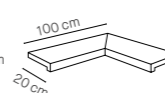
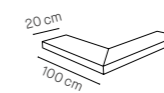
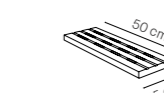
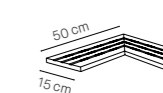
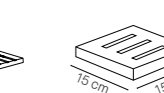
					
P.V. (POOL COPING)	ANG.P.V. (POOL COPING INTERNAL CORNER)	E.P.V. (POOL COPING EXTERNAL CORNER)	REJ. (DRAINAGE GRATE)	ANG.REJ. (ANGLE CORNER DRAINAGE GRATE)	T.REJ. (SQUARE CORNER DRAINAGE GRATE)
20x100x2 cm 8x39.4x0.8 "	100x100x2 cm 39.4x39.4x0.8 "	100x100x2 cm 39.4x39.4x0.8 "	15x50x2 cm 6x19.7x0.8 "	50x50x2 cm 19.7x19.7x0.8 "	15x15x2,3 cm 6x6x0.9 "

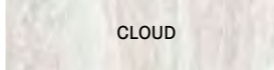
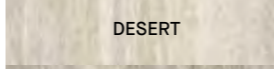
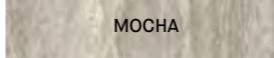
	CLOUD	Antislip (A)	35418 U82	35424 U86	35430 U86	35436 U54	35439 U86	35442 U71
	DESERT	Antislip (A)	35417 U82	35428 U86	35431 U86	35437 U54	35440 U86	35443 U71
	MOCHA	Antislip (A)	35419 U82	35429 U86	35432 U86	35438 U54	35441 U86	35444 U71

COMPLEMENTARY PIECES PIEZAS COMPLEMENTARIAS

S.K.I. S.K.D.

SKIRTING



8x30 cm
3.1x11.8 "

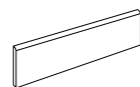

8x100 cm 8x75,5 cm 8x60 cm
3.1x39.4 " 3.1x29.7 " 3.1x23.6 "

Shaped (SP) 8 mm	U53	Shaped (SP) 8 mm	U45	-	-
All in One (AS)	U53	All in One (AS)	-	U43	U35
Polished (EP)	U53	Polished (EP)	-	U43	-

STAIR TREADS

TECHNICAL (PT) SEAMLESS (PL/18)

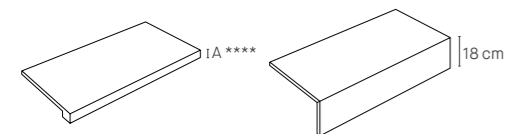

30x180 cm 30x151 cm 30x120 cm 30x100 cm 30x75,5 cm 30x60 cm
11.8x70.8 " 11.8x59.4 " 11.8x47.2 " 11.8x39.4 " 11.8x29.7 " 11.8x23.6 "

Shaped (SP) 8 mm	U90	-	-	U74	-	-
All in One (AS)	-	U86	U75	-	U76	U54
Polished (EP)	-	U86	-	-	U76	-

**** When thickness is 6 mm, A = 18 mm; when 8 mm, then A = 24 mm; when 10 mm, then A = 30 mm.
**** Cuando el espesor es 6 mm, A = 18 mm; cuando es 8 mm, A = 24 mm; cuando es 10 mm, A = 30 mm.

CALACATTA 4D

Developed using MUSEUM's cutting-edge 4D TECH technology, the CALACATTA 4D collection stands out for its ultra-white background and exclusive pattern, inspired by *Calacatta* marble.

The field tiles come in 100x275 cm format in a Premium Polished or Natural finish, in a choice of two colours: Extra White and Extra Gold. There is also a *book match* model, as an accompanying decorative feature. And it is also available in the Extra White color in 180x100 cm and 100x100 cm formats, both in Natural and Premium Polished finish.

Desarrollada con la última tecnología MUSEUM 4D TECH, la colección CALACATTA 4D destaca por su base extra blanca y su exclusiva gráfica inspirada en el mármol *Calacatta*.

Su base se encuentra disponible en formato 100x275 cm en acabado Pulido premium y Natural, en dos versiones de color: Extra White y Extra Gold, además de ir acompañada con su correspondiente *book match* como elemento decorativo. Y también está disponible el color Extra White en formatos 100x180 cm y 100x100 cm, tanto en acabado Natural como Premium Polished.



COLOURS

EXTRA WHITE



EXTRA GOLD







FINISHES

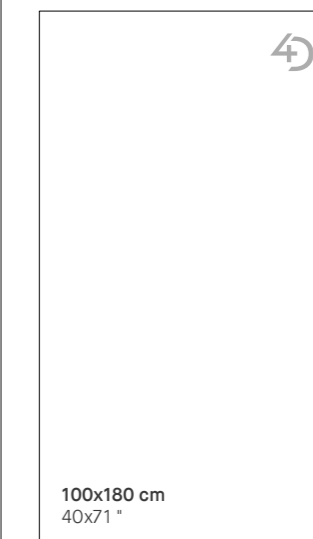
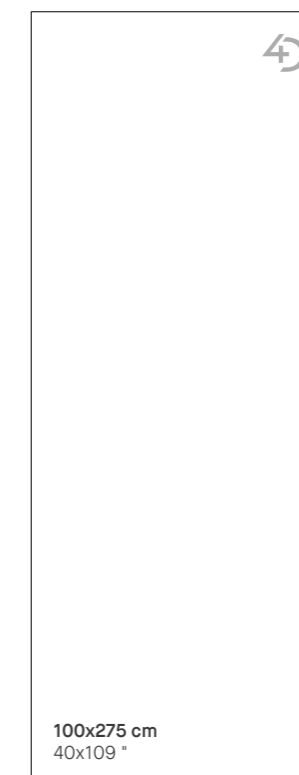

FORMATS

150x320 cm available (ELEVATE WORKTOPS).
Disponible 150x320 cm (ELEVATE WORKTOPS).



- 01.  &  CALACATTA EXTRA GOLD/100X275/P
- 02.  CALACATTA EXTRA WHITE/100X275/P
- 03.  CALACATTA EXTRA WHITE NT/100X275/R
- 04. CALACATTA EXTRA GOLD close-up



Scan and discover CALACATTA 4D:
Escanee y descubra CALACATTA 4D:







PATTERNS VARIETY VARIEDAD GRÁFICA CALACATTA WHITE 100x180 cm FORMAT CALACATTA WHITE FORMATO 100x180 cm

FORMATS FORMATOS

		Porcelain Porcelánico		
		100x275 cm 40x109 "	100x180 cm 40x71 "	100x100 cm 40x40 "
Thickness Espesor		6 mm	8 mm	
Patterns Gráficas		4	20	20
EXTRA WHITE	Premium Polished (P)	36874 M87	24203 M76	24206 M70
	Natural (NT)	36871 M95	23211 M75	23977 M69
EXTRA GOLD	Premium Polished (P)	36868 M87	-	-
	Natural (NT)	36867 M95	-	-

Porcelain Porcelánico

BOOK MATCH 100x275 cm 40x109 "

EXTRA WHITE	Premium Polished (P)	A	36872 M88
		B	36873 M88
	Natural (NT)	A	36869 M100
		B	36870 M100
EXTRA GOLD	Premium Polished (P)	A	36865 M88
		B	36866 M88
	Natural (NT)	A	36863 M100
		B	36864 M100

Book Match option 1



Book Match option 2

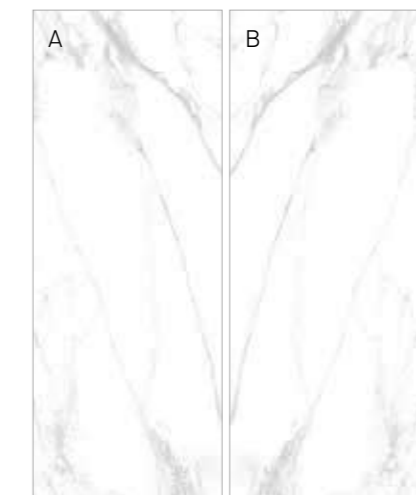

COMPLEMENTARY PIECES PIEZAS COMPLEMENTARIAS

S.K.I. S.K.D.



8x30 cm
3.1x11.8"

SKIRTING

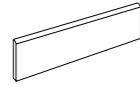

8x100 cm
3.1x39.4"

Premium Polished (P)	U53	Premium Polished (P)	U48
Natural (NT)	U53	Natural (NT)	U45

STAIR TREADS

TECHNICAL (PT) SEAMLESS (PL/18)

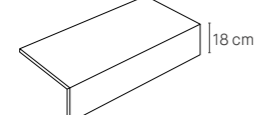
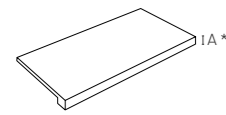

18 cm
30x180 cm 30x100 cm
11.8x70.8" 11.8x39.4"

Premium Polished (P)	U90	U74
Natural (NT)	U90	U74

* When thickness is 6 mm, A = 18 mm; when 8 mm, then A = 24 mm.
* Cuando el espesor es 6 mm, A = 18 mm; cuando es 8 mm, A = 24 mm.

TECHNICAL DATA DATOS TÉCNICOS

	DIN 51130	DIN 51097	UNE-41901 EX	BS 7976-2 (PTV)	ANSI A137.1 (DCOF)
Natural (NT)	-	-	Class 1	-	>0,42

	100x275 cm 40x109"	100x180 cm 40x71"
Premium Polished (P) & Natural (NT)	E3 C2	E3 C2

06. ■ BM CALACATTA EXTRA WHITE A/100X260/P & BM CALACATTA EXTRA WHITE B/100X275/P



CHICAGO

The CHICAGO collection features a restful looking stone pattern with a nebulous appearance, where one shade merges into the next, lending it a chic modern appearance.

It comes in a choice of four natural looking shades —Cloud, Road, Mocha and Moon— in a wide variety of formats —100x275 cm, 100x180 cm, 100x100 cm, 50x100 cm, 60x120 cm and 90x90 cm— and a Shaped, Natural or Antislip finish. The collection also features a 50x150 cm model, made with brand new 4D WALL technology, conceived to bring an added natural appeal to living spaces, thanks to its size and unparalleled Shaped finish.

La colección CHICAGO representa una piedra calmada, cuya gráfica nebulosa se entremezcla tono sobre tono, adquiriendo un estilo de lo más contemporáneo.

Sus tonalidades naturales son 4: Cloud, Road, Mocha y Moon. En una gran variedad de formatos como son 100x275 cm, 100x180 cm, 100x100 cm, 50x100 cm, 60x120 cm, 90x90 cm, en acabados Shaped, Natural y Antislip. Además, se incorpora una nueva tecnología 4D WALL en formato 50x150 cm, para aportar mayor naturalidad a los espacios gracias a su dimensión y su acabado Shaped por excelencia.



COLOURS



FINISHES



FORMATS

Special Pieces Piezas Especiales

D. MOSAIC	D. MIX	D. GEO
30x30 cm 11.8x11.8"	30x30 cm 11.8x11.8"	White Body 25x25 cm 9.8x9.8"



- 01. ■ & ■ CHICAGO MOCHA NT/60X120/R
- 02. ■ CHICAGO CLOUD SP/100X275/R
- 03. ■ D.CHICAGO MOON GEO SP/25X25
- 04. ■ CHICAGO ROAD SP/100X100X2/A/R
- 05. CHICAGO ROAD close-up.

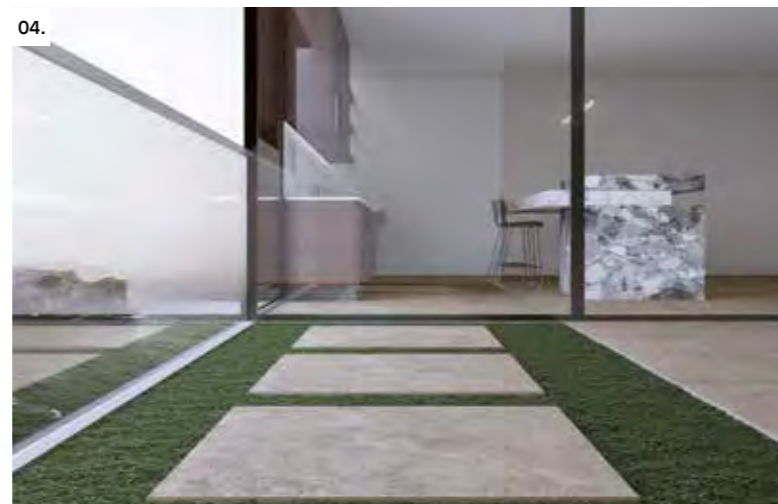

Scan and discover CHICAGO:
Escanee y descubra CHICAGO:



06.



- 06. ■ CHICAGO ROAD SP/100X275/R ■ CHICAGO ROAD SP/100X100/R
- 07. CHICAGO ROAD SP

07.





09.



- 08. ■ CHICAGO MOCHA SP/100X180/R & CHICAGO MOCHA SP/100X275/R ■ GROW PORTO SP/24X151/R
- 09. ■ CHICAGO CLOUD SP/50X150/R ■ GROW TAUPE SP/24X151/R
- 10. ■ CHICAGO CLOUD DECOR SP/50X150/R

10.







PATTERNS VARIETY VARIEDAD GRÁFICA CHICAGO MOON 60x120 cm FORMAT CHICAGO MOON FORMATO 60x120 cm

FORMATS FORMATOS

		Porcelain Porcelánico				White Body Pasta Blanca			
		100x275 cm 40x109"	100x180 cm 40x71"	100x100 cm 40x40"	50x100 cm 20x40"	60x120 cm 24x48"	90x90 cm 36x36"	50x150 cm 20x60"	50x150 cm 20x60" DECOR
Thickness Espesor		6 mm	8 mm / 20 mm*	20 mm	10 mm		7,5 mm		
Patterns Gráficas		10	10	10	20	12	18	18	
CLOUD	Shaped (SP)	35936 M90	31758 M94	31824 M93	-	-	-	31967 M105	31971 M106
	Natural (NT)	-	-	-	-	31767 M101	31883 M102	-	-
	Antislip (A)	-	-	36389* M113	36803 M115	-	31887 M81	-	-
ROAD	Shaped (SP)	36618 M90	31759 M94	31827 M93	-	-	-	31969 M105	31974 M106
	Natural (NT)	-	-	-	-	31769 M101	31886 M102	-	-
	Antislip (A)	-	-	36392* M113	36806 M115	-	31888 M81	-	-
MOCHA	Shaped (SP)	36619 M90	31820 M94	31825 M93	-	-	-	31968 M105	31972 M106
	Natural (NT)	-	-	-	-	31821 M101	31884 M102	-	-
	Antislip (A)	-	-	36390* M113	36804 M115	-	31889 M81	-	-
MOON	Shaped (SP)	35922 M90	31760 M94	31826 M93	-	-	-	31970 M105	31973 M106
	Natural (NT)	-	-	-	-	31768 M101	31885 M102	-	-
	Antislip (A)	-	-	36391* M113	36805 M115	-	31890 M81	-	-

TECHNICAL DATA DATOS TÉCNICOS

	DIN 51130	DIN 51097	UNE-41901 EX	BS 7976-2 (PTV)	ANSI A137.1 (DCOF)
Shaped (SP)	-	-	Class 1	-	>0,42
Natural (NT)	R10	A + B	Class 2	+36 Wet	>0,42
Antislip (A)	R11	A + B + C	Class 3	+36 Wet	>0,42

SPECIAL PIECES PIEZAS ESPECIALES

Porcelain Porcelánico (10 mm)

D. MOSAIC 30x30 cm 11.8x11.8 "			
	CLOUD	Natural (NT)	32200 U36
	ROAD	Natural (NT)	32201 U36
	MOCHA	Natural (NT)	32202 U36
	MOON	Natural (NT)	32203 U36

White Body Pasta Blanca (7,5 mm)

* D. GEO 25x25 cm 9.8x9.8 "			
	CLOUD	Shaped (SP)	32195 U58
	ROAD	Shaped (SP)	32196 U58
	MOCHA	Shaped (SP)	32197 U58
	MOON	Shaped (SP)	32198 U58

Porcelain Porcelánico (10 mm)

**D. MIX 30x30 cm 11.8x11.8 "			
	CHICAGO MOON	Natural (NT)	32073 U55
	GROW DOLPHIN	Shaped (SP)	
	HAUTE WHITE	Shaped (SP)	
	DUAL WHITE	Natural (NT)	32072 U55
	GROW KALUA	Shaped (SP)	
	CHICAGO MOCHA	Natural (NT)	

COMPLEMENTARY PIECES PIEZAS COMPLEMENTARIAS

S.K.I. S.K.D.

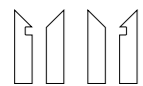

8x30 cm
3.1x11.8 "

SKIRTING

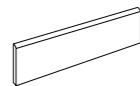

8x100 cm 3.1x39.4 "
8x90 cm 3.1x35.4 "
8x60 cm 3.1x23.6 "

	U53	U45	-	-
Shaped (SP)	U53	-	-	-
Natural (NT)	U53	-	U44	U35
Antislip (A)	U53	-	U44	-

STAIR TREADS

TECHNICAL (PT) SEAMLESS (PL/18)

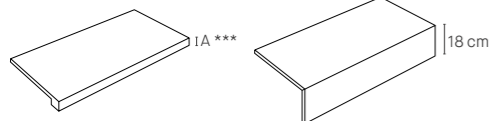

1A *** 18 cm
30x180 cm 11.8x70.8 "
30x120 cm 11.8x47.2 "
30x100 cm 11.8x39.4 "
30x90 cm 11.8x35.4 "
30x60 cm 11.8x23.6 "

	U90	-	U74	-	-
Shaped (SP)	U90	-	U74	-	-
Natural (NT)	-	U75	-	U76	U54
Antislip (A)	-	-	-	U76	-

*** When thickness is 6 mm, A = 18 mm; when 8 mm, then A = 24 mm; when 10 mm, then A = 30 mm.
*** Cuando el espesor es 6 mm, A = 18 mm; cuando es 8 mm, A = 24 mm; cuando es 10 mm, A = 30 mm.

POOL PIECES PIEZAS DE PISCINA

Porcelain Porcelánico

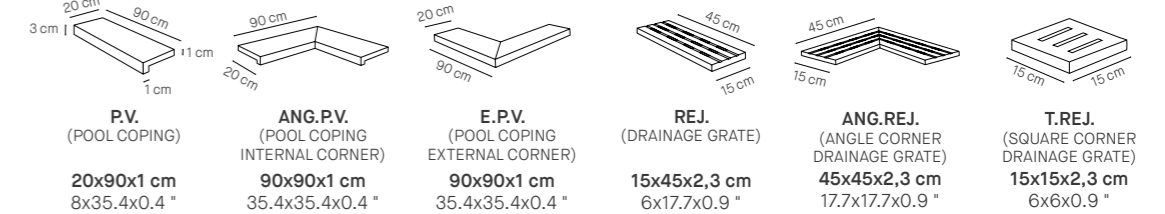

CLOUD	Antislip (A)	32228 U81	32232 U75	32236 U75	32240 U54	32244 U75	32248 U71
ROAD	Antislip (A)	32229 U81	32233 U75	32237 U75	32241 U54	32245 U75	32249 U71
MOCHA	Antislip (A)	32230 U81	32234 U75	32238 U75	32242 U54	32246 U75	32250 U71
MOON	Antislip (A)	32231 U81	32235 U75	32239 U75	32243 U54	32247 U75	32251 U71

* Only suitable for wall installations.
* Adecuado únicamente como revestimiento.

** Random colour position.
** Posición de colores aleatoria.



12. ■ CHICAGO ROAD/90X90/A/C/R & P.V./20X90/A/C/R & ANG.P.V./20X90/A/C/R & E.P.V./20X90/A/C/R & REJ./15X45/A/C/R & ANG.REJ./15X45/A/C/R
■ & ■ D.CHICAGO ROAD MOSAIC SP/30X30 & PL/18 CHICAGO ROAD/30X90

CRYSTAL

CRYSTAL reproduces the profundity of quartz, with all the realism of the genuine article. The subtle veins in its select design give it a delicate personality.

The collection comes in a choice of two colours able to infuse settings with subtle beauty: White, synonymous with soothing luminosity; and Thunder, a warmer option. Its 75.5x151 cm and 60x120 cm formats come in a single Polished finish.

Cuando la profundidad gráfica de un cuarzo se plasma como en la naturaleza surge CRYSTAL, un diseño especial que con su ligero veteado aporta personalidad y sensibilidad al mismo tiempo.

Su tono White representa la calma y claridad a los espacios, mientras que el tono Thunder representa el carácter cálido de los mismos, ambos permiten convertir cualquier espacio en delicado y fino. Se encuentra disponible en 75,5x151 cm y 60x120 cm, en un único acabado Polished.



COLOURS

WHITE



THUNDER



FINISHES



FORMATS

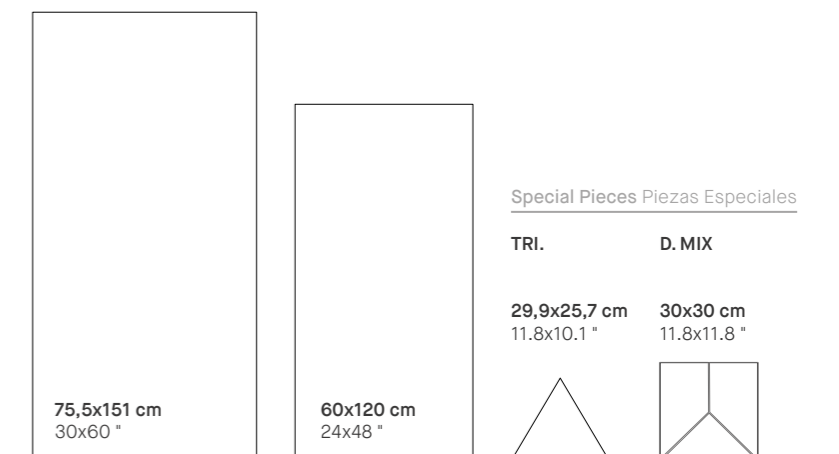

- 01. ■ CRYSTAL WHITE/75,5X151/EP
- 02. 03. CRYSTAL WHITE/75,5X151/EP in a private bathroom. Architect: Lasut&Braun. Photography: Jaro van Meerten.
- 04. CRYSTAL WHITE close-up

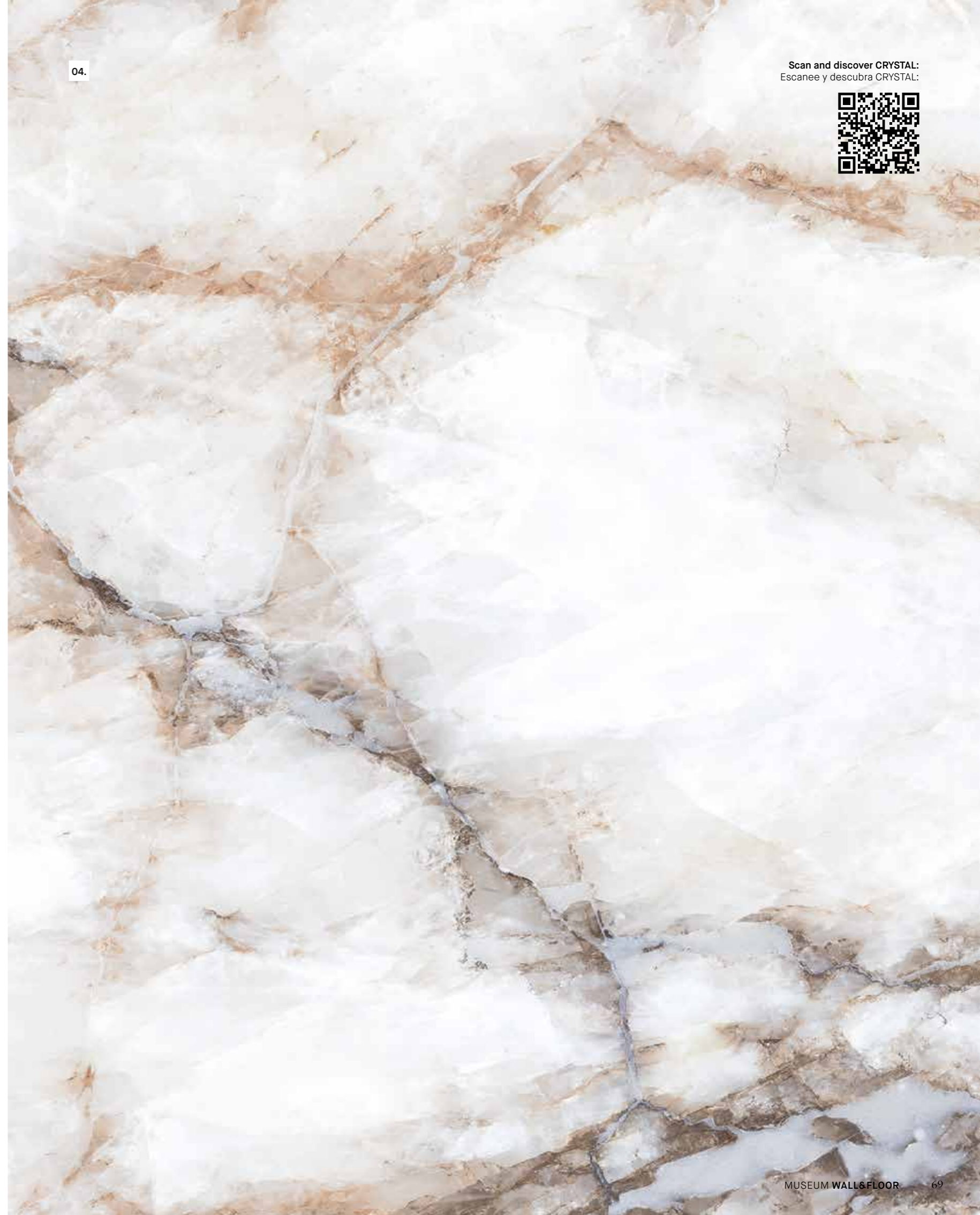

Scan and discover CRYSTAL:
Escanee y descubra CRYSTAL:









PATTERNS VARIETY VARIEDAD GRÁFICA CRYSTAL THUNDER 75,5x151 cm FORMAT CRYSTAL THUNDER FORMATO 75,5x151 cm

FORMATS FORMATOS

		Porcelain Porcelánico	
		75,5x151 cm 30x60 "	60x120 cm 24x48 "
Thickness Espesor		10 mm	
Patterns Gráficas		15	14
	WHITE Polished (EP)	28563 M58	28561 M40
	THUNDER Polished (EP)	28564 M58	28562 M40

SPECIAL PIECES PIEZAS ESPECIALES

Porcelain Porcelánico (10 mm)				Porcelain Porcelánico (10 mm)			
TRI.	29,9x25,7 cm 11.8x10.1 "			*D. MIX	30x30 cm 11.8x11.8 "		
	WHITE	Polished (EP)	29171 U34		CRYSTAL WHITE CRYSTAL THUNDER MARQUINA BLACK	Polished (EP)	29172 U51
	THUNDER	Polished (EP)	29170 U34				

* Random colour position.
* Posición de colores aleatoria.

COMPLEMENTARY PIECES PIEZAS COMPLEMENTARIAS

S.K.I.	S.K.D.	SKIRTING			
Polished (EP)	U53	8x30 cm 3.1x11.8 "	8x75,5 cm 3.1x29.7 "	8x60 cm 3.1x23.6 "	
			Polished (EP)	U43	U35
STAIR TREADS					
TECHNICAL (PT)		SEAMLESS (PL/18)			
	13 cm		18 cm	30x151 cm 11.8x59.4 "	30x120 cm 11.8x47.2 "
				30x75,5 cm 11.8x29.7 "	30x60 cm 11.8x23.6 "
		Polished (EP)		U86	U75
				U76	U54

DREAMY

DREAMY is a collection that conjures up images of the home of your dreams. The collection's design is inspired by *Illusion Bronze* marble, further enhanced by a set of stone conglomerates, which lend its rich veined pattern a fascinating depth. DREAMY comes in two pale shades —Cloud, in a colder shade, and Desert, in a warmer one— and two darker colours with more shade variation —Road, in warm grey shades, and Mocha, in dark brown ones—.

The collection is available in 100x180 cm, 100x100 cm, 75.5x151 cm and 60x120 cm formats in Shaped, Polished and All In One finishes.

La colección DREAMY nos traslada a la casa de nuestros sueños, Su gráfica inspirada en el mármol Illusion Bronze se ve potenciada por un conjunto de conglomerados pétreos que le aportan profundidad en su rico vetado. Sus tonalidades se agrupan en dos tonos claros —uno más frío y otro más cálido— que serían Cloud y Desert, y dos tonos más oscuros —que contienen mayor variedad cromática— como son Road y Mocha, gris cálido y marrón intenso.

Disponible en los formatos 100x180 cm, 100x100 cm, 75,5x151 cm y 60x120 cm, con una gran variedad de acabados como son Shaped, Polished y All In One.



COLOURS

CLOUD



DESERT



ROAD



MOCHA

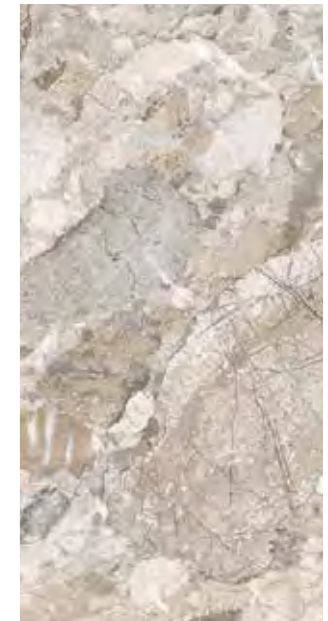

FINISHES



FORMATS

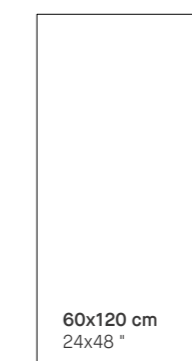
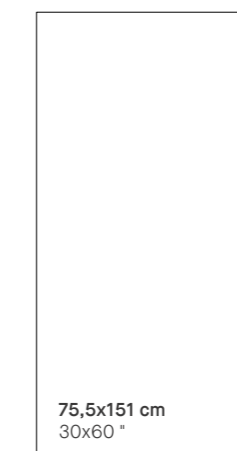
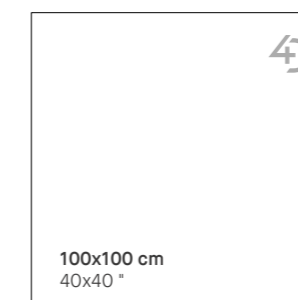
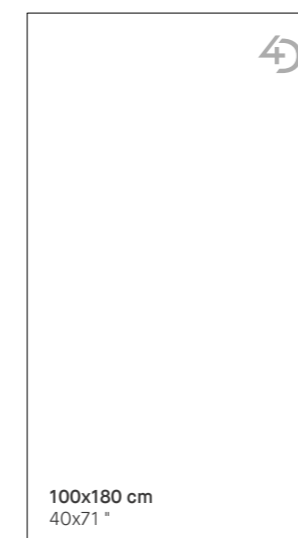

Special Pieces Piezas Especiales



D. ARROW

D. TRIANGLE

30x30 cm
11.8x11.8"

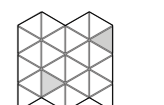
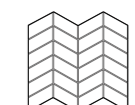
29x29 cm
11.4x11.4"



- 01.  &  DREAMY MOCHA AS/75,5X151/R
- 02.  DREAMY ROAD SP/100X180/R
- 03. 04. DREAMY MOCHA AS/60X120/C/R in a public space in Amsterdam, designed by Lasut&Braun.
- 05. DREAMY ROAD close-up

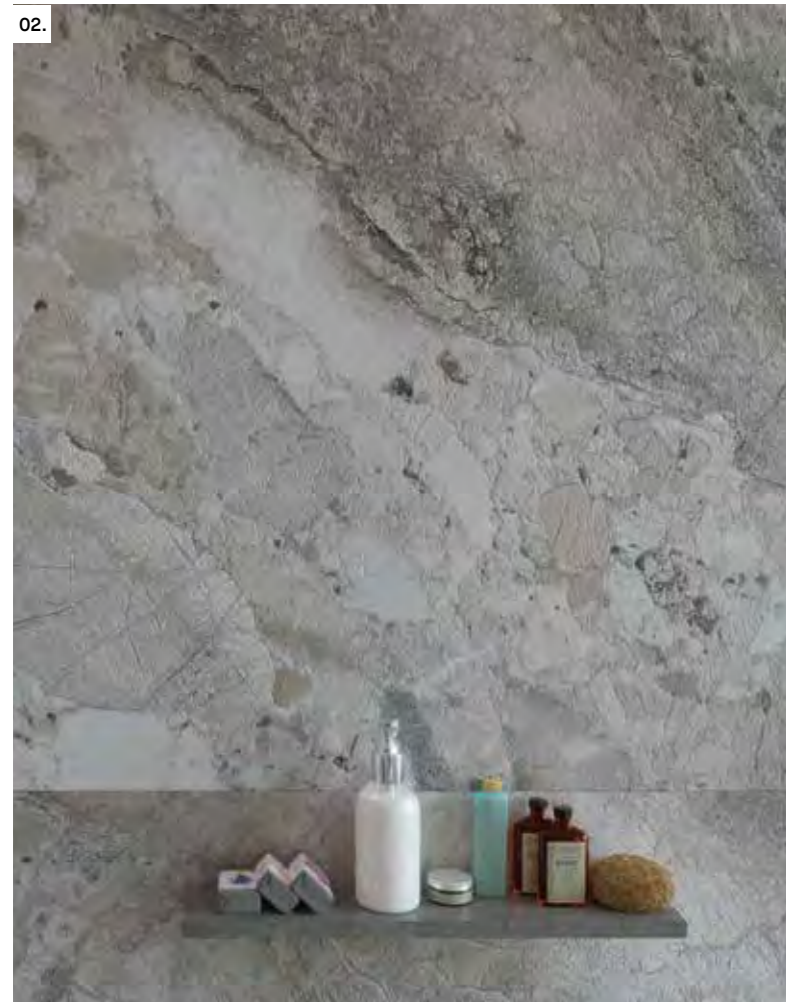

Scan and discover DREAMY:
Escanee y descubra DREAMY:







08.



- 07. ■ DREAMY CLOUD AS/60X120/R
- 08. ■ DREAMY MOCHA 60X120/EP
- 09. ■ DREAMY DESERT 75,5X151/EP

09.





PATTERNS VARIETY VARIEDAD GRÁFICA DREAMY MOCHA 60x120 cm FORMAT DREAMY MOCHA FORMATO 60x120 cm

FORMATS FORMATOS

		Porcelain Porcelánico			
		100x180 cm 40x71"	100x100 cm 40x40"	75,5x151 cm 30x60"	60x120 cm 24x48"
Thickness Espesor		8 mm		10 mm	
Patterns Gráficas		10	12	16	25
CLOUD	Shaped (SP)	29773 M94	29790 M93	-	-
	Polished (EP)	-	-	27362 M58	27358 M40
	All in One (AS)	-	-	-	27360 M91
DESERT	Shaped (SP)	29771 M94	30284 M93	-	-
	Polished (EP)	-	-	30288 M58	30142 M40
	All in One (AS)	-	-	-	30279 M91
ROAD	Shaped (SP)	29780 M94	29787 M93	-	-
	Polished (EP)	-	-	27361 M58	27357 M40
	All in One (AS)	-	-	-	27359 M91
MOCHA	Shaped (SP)	29772 M94	30285 M93	-	-
	Polished (EP)	-	-	30289 M58	30143 M40
	All in One (AS)	-	-	-	30278 M91

TECHNICAL DATA DATOS TÉCNICOS

	DIN 51130	DIN 51097	UNE-41901 EX	BS 7976-2 (PTV)	ANSI A137.1 (DCOF)
Shaped (SP)	-	-	Class 1	-	>0,42
All in One (AS)	R11	A + B + C	Class 3	+36 Wet	>0,42

SPECIAL PIECES PIEZAS ESPECIALES

Porcelain Porcelánico (10 mm)

D. ARROW		30x30 cm 11.8x11.8 "	
	CLOUD	Polished (EP)	30375 U64
		All in One (AS)	30371 U64
	DESERT	Polished (EP)	30376 U64
		All in One (AS)	30372 U64
	ROAD	Polished (EP)	30377 U64
		All in One (AS)	30374 U64
	MOCHA	Polished (EP)	30378 U64
		All in One (AS)	30373 U64

Porcelain Porcelánico (10 mm)

* D. TRIANGLE		29x29 cm 11.4x11.4 "	
	CLOUD	All in One (AS)	35285 U58
		DESERT	All in One (AS)

* Only suitable for wall installations.
* Adecuado únicamente como revestimiento.

POOL PIECES PIEZAS DE PISCINA

Porcelain Porcelánico

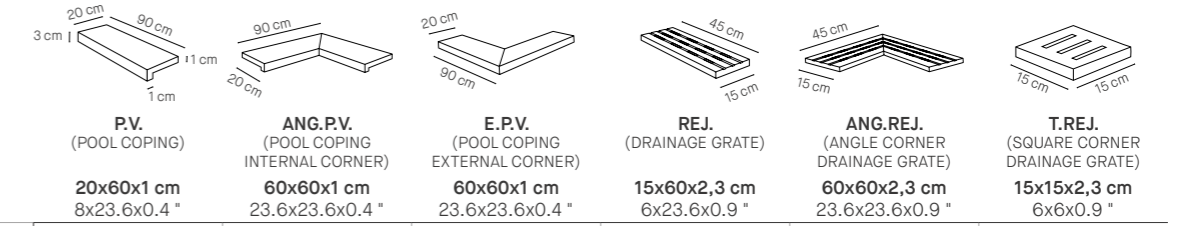

Pattern	Finish	Product Code	Dimensions
CLOUD	All in One (AS)	30401 U61	20x60x1 cm 8x23.6x0.4 "
	All in One (AS)	30402 U61	20x60x1 cm 8x23.6x0.4 "
DESERT	All in One (AS)	30402 U61	20x60x1 cm 8x23.6x0.4 "
	All in One (AS)	30403 U61	20x60x1 cm 8x23.6x0.4 "
ROAD	All in One (AS)	30404 U61	20x60x1 cm 8x23.6x0.4 "
	All in One (AS)	30404 U61	20x60x1 cm 8x23.6x0.4 "
MOCHA	All in One (AS)	30403 U61	20x60x1 cm 8x23.6x0.4 "
	All in One (AS)	30403 U61	20x60x1 cm 8x23.6x0.4 "

COMPLEMENTARY PIECES PIEZAS COMPLEMENTARIAS

S.K.I. S.K.D.

SKIRTING



8x30 cm
3.1x11.8 "

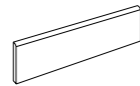

8x100 cm 3.1x39.4 "
8x75,5 cm 3.1x29.7 "
8x60 cm 3.1x23.6 "

Finish	Product Code	Product Code	Product Code	Product Code
Polished (EP)	U53	-	U43	U35
Shaped (SP)	U53	U45	-	-
All in One (AS)	U53	-	-	U35

STAIR TREADS

TECHNICAL (PT)

SEAMLESS (PL/18)

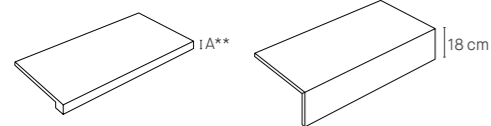

30x180 cm 11.8x70.8 "
30x151 cm 11.8x59.4 "
30x120 cm 11.8x47.2 "
30x100 cm 11.8x39.4 "
30x75,5 cm 11.8x29.7 "
30x60 cm 11.8x23.6 "

Finish	Product Code	Product Code	Product Code	Product Code	Product Code
Polished (EP)	-	U86	U75	-	U76
Shaped (SP)	U90	-	-	U74	-
All in One (AS)	-	-	U75	-	U54

** When thickness is 8 mm, then A = 24 mm; when 10 mm, then A = 30 mm.
** Cuando el espesor es 8 mm, A = 24 mm; cuando es 10 mm, A = 30 mm.



10. ■ D. DREAMY MOCHA ARROW/30X30/EP

DUAL

DUAL is a collection with a classy air of distinction, inspired by warm-looking marble. With its snowy white background and stylized golden and grey veins, it infuses living spaces with elegance and luminosity.

The collection comes in a 100x275 cm, 100x180 cm, 100x100 cm, 75.5x151 cm or 60x120 cm format in a choice of a Premium Polished, Polished, Shaped or Natural finish. DUAL is rounded off with a 33.3x100 cm sinuous looking relief tile made with cutting-edge Deeptech technology.

La inspiración en un mármol cálido da lugar a nuestra exclusiva colección DUAL. Destacable por su blancura de fondo y sus estilizadas vetas en tonos dorados y grises, creando superficies de lo más luminosas y elegantes.

Disponible en los formatos 100x275 cm, 100x180 cm, 100x100 cm, 75,5x151 cm, 60x120 cm, en acabados Premium Polished, Polished, Shaped y Natural. Además, se complementa con un sinuoso relieve en 33,3x100 cm con la innovadora tecnología Deeptech.



COLOURS

WHITE



FINISHES

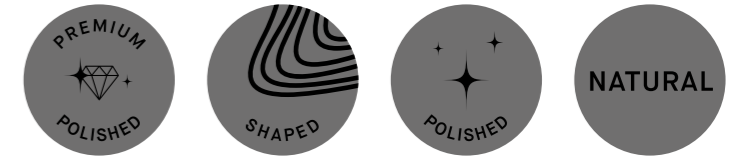



FORMATS

150x320 cm available (ELEVATE WORKTOPS).
Disponible 150x320 cm (ELEVATE WORKTOPS).

Special Pieces Piezas Especiales

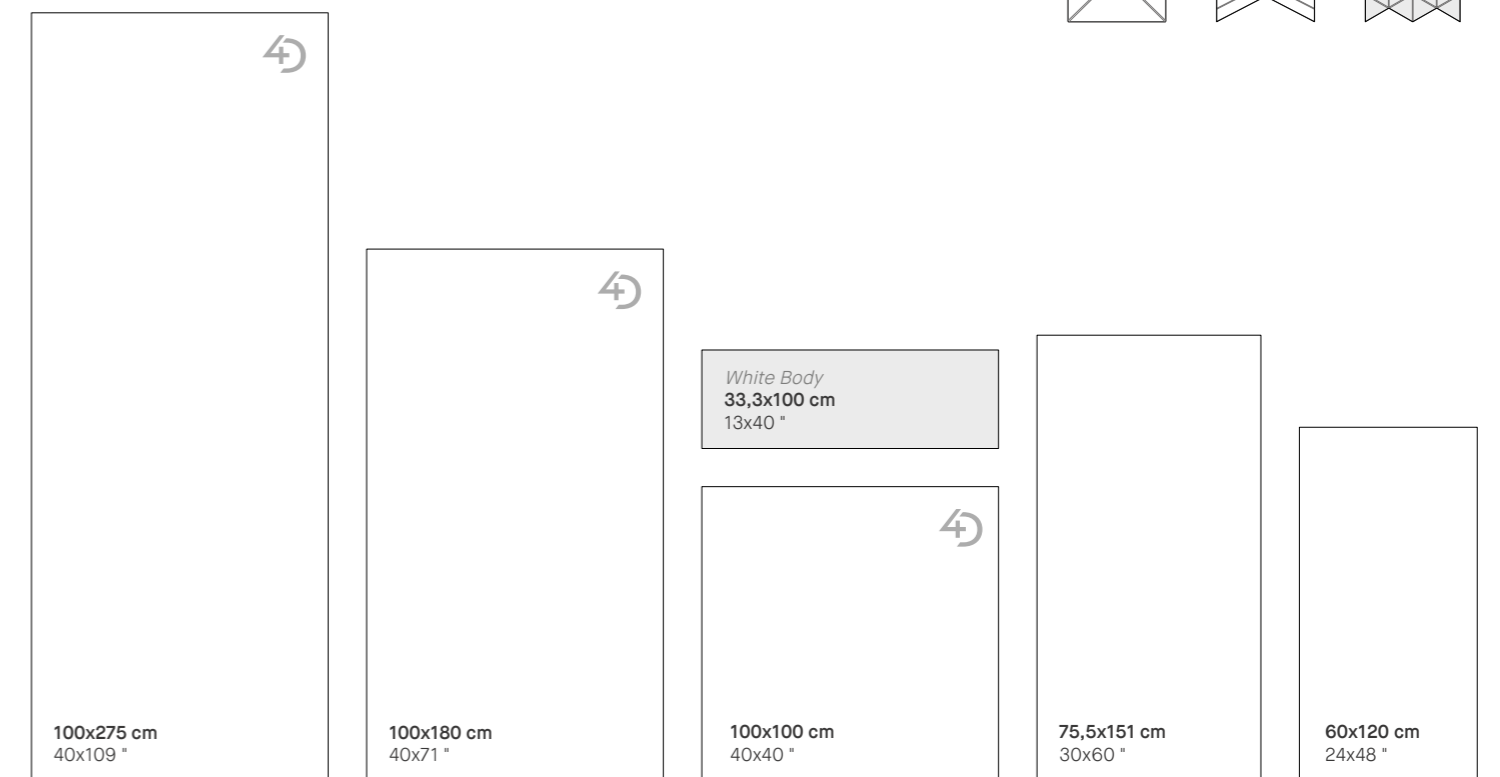
D. MIX	D. CHEVRON	D. TRIANGLE
30x30 cm 11.8x11.8"	30x21,9 cm 11.8x8.6"	White Body 29x29 cm 11.4x11.4"



- 01.  DUAL WHITE NT/60X120/R
- 02. 03. DUAL WHITE DECOR SP/33,3X100/R at Dom Apex showroom
- 04. DUAL WHITE close-up



Scan and discover DUAL:
Escanee y descubra DUAL:





06.



05.

■ DUAL WHITE SP/100X180/R

06.

■ DUAL WHITE SP/100X275/R & GROW KALUA SP/33,3X100/R ■ DUAL WHITE SP/100X100/R & GROW KALUA SP/24X151/R

07.

DUAL WHITE SP

07.







PATTERNS VARIETY VARIEDAD GRÁFICA DUAL WHITE 100x180 cm FORMAT DUAL WHITE FORMATO 100x180 cm

FORMATS FORMATOS

		Porcelain Porcelánico				White Body Pasta Blanca		
		100x275 cm 40x109 "	100x180 cm 40x71 "	100x100 cm 40x40 "	75,5x151 cm 30x60 "	60x120 cm 24x48 "	33,3x100 cm 13x40 "	33,3x100 cm 13x40 "
		DECOR						
Thickness Espesor		6 mm	8 mm		10 mm		10,5 mm	13,5 mm
Patterns Gráficas		7	11	11	10	14	20	20
WHITE	Premium Polished (P)	-	31745 M76	-	-	-	-	-
	Shaped (SP)	36058 M100	31744 M94	31743 M93	-	-	31787 M96	31788 M97
	Polished (EP)	-	-	-	31742 M58	31741 M40	-	-
	Natural (NT)	-	-	-	31740 M103	31739 M101	-	-

TECHNICAL DATA DATOS TÉCNICOS

	DIN 51130	DIN 51097	UNE-41901 EX	BS 7976-2 (PTV)	ANSI A137.1 (DCOF)
Shaped (SP)	-	-	Class 1	-	>0,42
Natural (NT)	R10	A + B	Class 2	+36 Wet	>0,42

SPECIAL PIECES PIEZAS ESPECIALES



Porcelain Porcelánico (10 mm)

D. MIX 30x30 cm 11.8x11.8 "			
	DUAL WHITE GROW KALUA CHICAGO MOCHA	Natural (NT) Shaped (SP) Natural (NT)	32072 U55

White Body Pasta Blanca (10,5 mm)

** D. TRIANGLE 29x29 cm 11.4x11.4 "			
	WHITE	Shaped (SP)	32070 U53

Porcelain Porcelánico (10 mm)

D. CHEVRON 30x21,9 cm 11.8x8.6 "			
	DUAL WHITE GROW PORTO	Polished (EP) Shaped (SP)	32077 U55
	DUAL WHITE GROW PORTO	Natural (NT) Shaped (SP)	32076 U55

* Random colour position.
* Posición de colores aleatoria.

** Only suitable for wall installations.
** Adecuado únicamente como revestimiento.

COMPLEMENTARY PIECES PIEZAS COMPLEMENTARIAS

S.K.I. S.K.D.



8x30 cm
3.1x11.8 "

SKIRTING

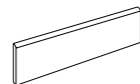

8x100 cm 8x75,5 cm 8x60 cm
3.1x39.4 " 3.1x29.7 " 3.1x23.6 "

Premium Polished (P)	U53	Premium Polished (P)	U48	-	-
Polished (EP)	U53	Polished (EP)	-	U43	U35
Shaped (SP)	U53	Shaped (SP)	U45	-	-
Natural (NT)	U53	Natural (NT)	-	U43	U35

STAIR TREADS

TECHNICAL (PT)

SEAMLESS (PL/18)

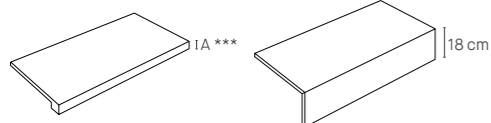

30x180 cm 30x151 cm 30x120 cm 30x100 cm 30x75,5 cm 30x60 cm
11.8x70.8 " 11.8x59.4 " 11.8x47.2 " 11.8x39.4 " 11.8x29.7 " 11.8x23.6 "

Premium Polished (P)	U90	-	-	U74	-	-
Polished (EP)	-	U86	U75	-	U76	U54
Shaped (SP)	U90	-	-	U74	-	-
Natural (NT)	-	U86	U75	-	U76	U54

*** When thickness is
6 mm, A = 18 mm;
when 8 mm, then A = 24 mm;
when 10 mm, then A = 30 mm.
*** Cuando el espesor es
6 mm, A = 18 mm;
cuando es 8 mm, A = 24 mm;
cuando es 10 mm, A = 30 mm.

09. ■ D. DUAL/KALUA/MOCHA MIX NT/30X30

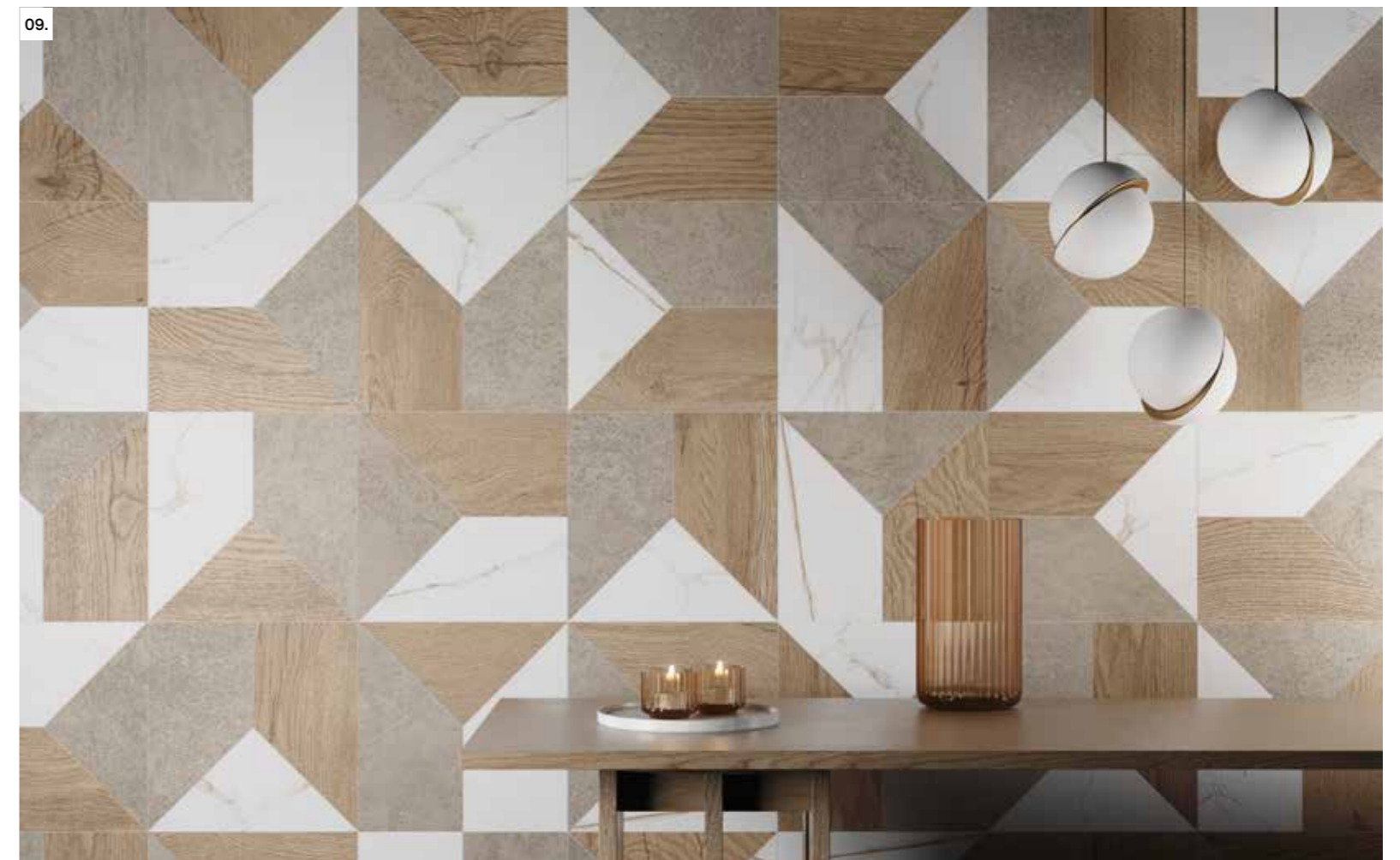

GROW

GROW encapsulates all the beauty of oak wood in a collection brimming with personality, conspicuous for its unique, exquisite looking knots.

With its 24x151 cm format and Shaped finish, the collection has a chic, modern appeal. Available in a choice of seven colours, including five warm shades —Maple, Taupe, Honey, Kalua and Porto— and two more neutral-looking ones —White and Dolphin—, the collection guarantees broad visual potential, thanks to its additional 33.3x100 cm strip-effect wall tiles in Taupe or Kalua.

La colección GROW interpreta una madera de roble natural, con mucha personalidad y una selección de nudos extremadamente cuidada y singular.

La aplicación del acabado Shaped en formato 24x151 cm, le confiere una estética vanguardista de lo más sofisticada. Su amplia gama cromática se compone de siete colores, cinco de ellos en un rango cálido —Maple, Taupe, Honey, Kalua y Porto— y dos más neutros —White y Dolphin—. En revestimiento se presenta un decorado a láminas en 33,3x100 cm, con los colores Taupe y Kalua, los cuales ofrecen infinidad de posibilidades estéticas.



COLOURS

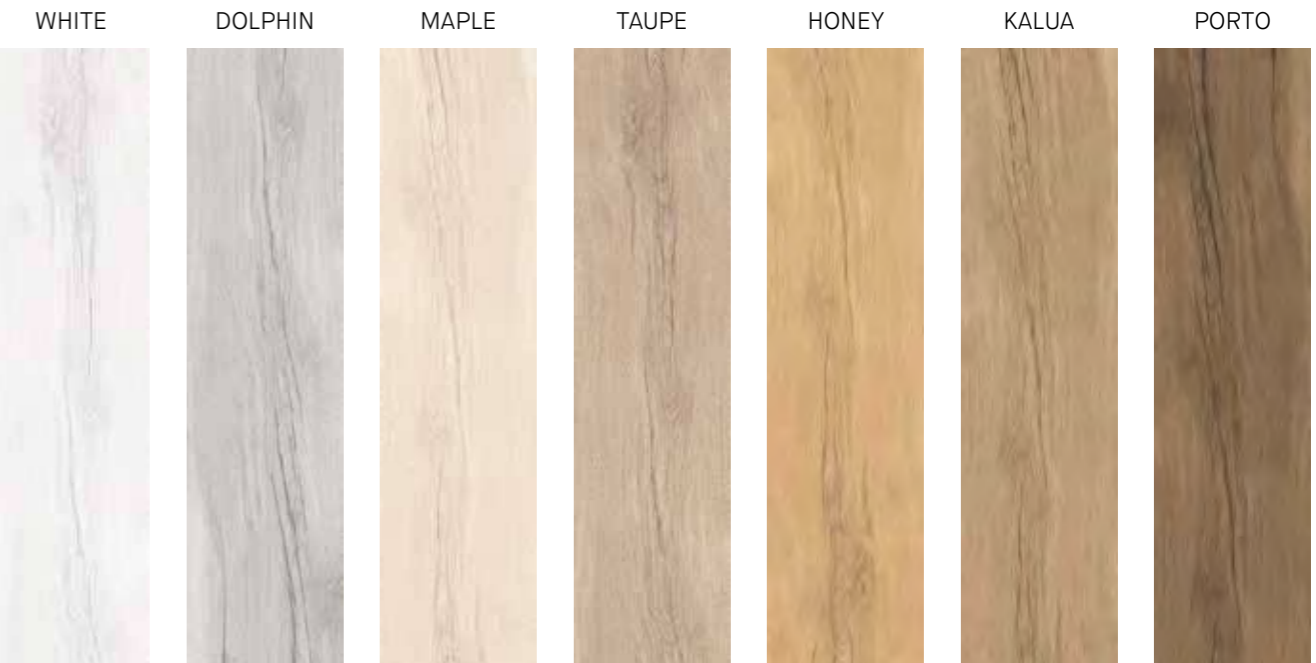

FINISHES



FORMATS

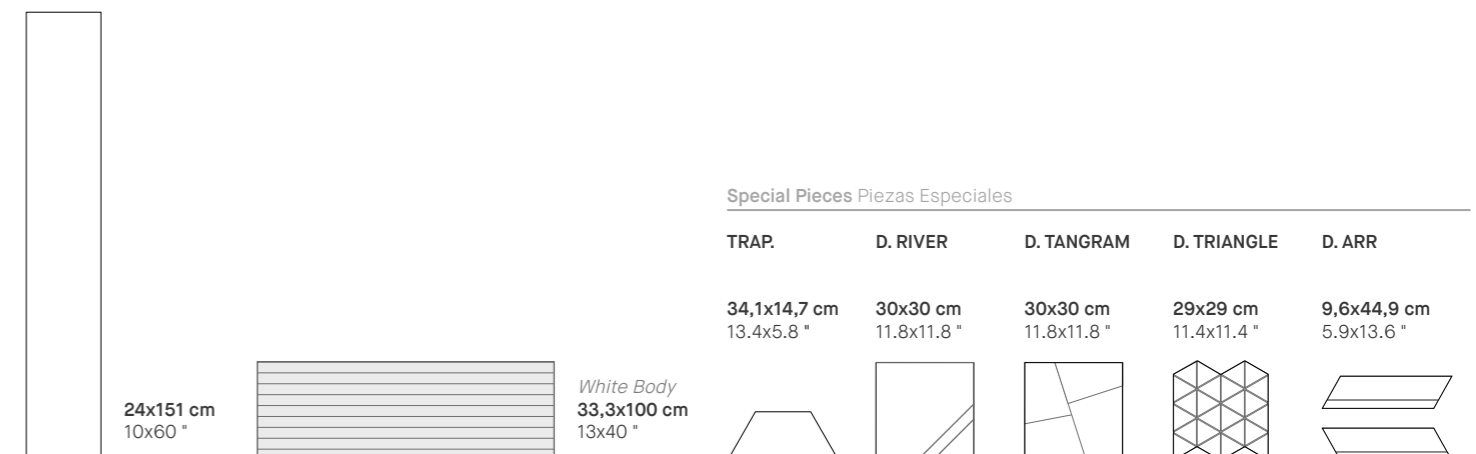

- 01.  GROW DOLPHIN SP/24X151/R
- 02. 03. GROW PORTO SP/24X151/R at the "Mono Viejo" restaurant of GM Group designed by Nothing Studio at Casa Decor 2022. Photography: Nacho Uribesalazar.
- 04. GROW TAUPE SP/24X151/R
- 05. GROW HONEY SP close-up



05.

Scan and discover GROW:
Escanee y descubra GROW:







07.

06. ■ & ■ GROW MAPLE SP/24X151/R ■ KRON CHARCOAL NT/100X275/R

07. ■ & ■ GROW KALUA SP/24X151/R ■ GROW KALUA SP/33X100/R

08. ■ GROW KALUA SP/33X100/R



08.



10.



- 09. ■ GROW TAUPE SP/24X151/R
- 10. ■ HAUTE WHITE SP/60X120/R ■ GROW PORTO SP/24X151/R
- 11. GROW PORTO SP

11.

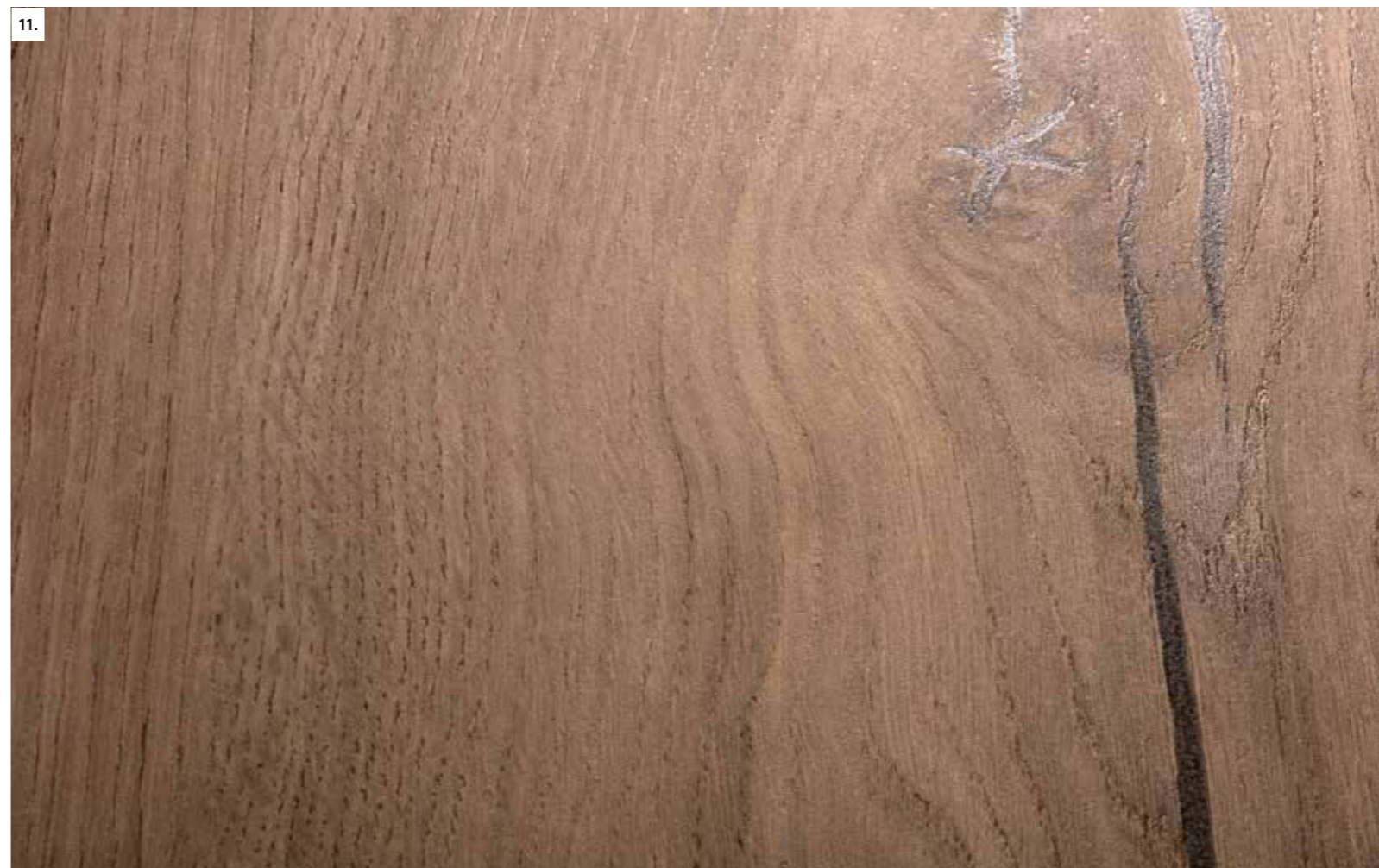



PATTERNS VARIETY VARIEDAD GRÁFICA GROW HONEY 24x151 cm FORMAT GROW HONEY FORMATO 24x151 cm

FORMATS FORMATOS

		Porcelain Porcelánico	White Body Pasta Blanca
		24x151 cm 10x60 "	33,3x100 cm 13x40 " DECOR
Thickness Espesor		10 mm	10,5 mm
Patterns Gráficas		36	8
WHITE	Shaped (SP)	30902 M104	-
DOLPHIN	Shaped (SP)	30906 M104	-
MAPLE	Shaped (SP)	30903 M104	-
TAUPE	Shaped (SP)	30905 M104	31096 M97
HONEY	Shaped (SP)	30904 M104	-
KALUA	Shaped (SP)	31279 M104	31095 M97
PORTO	Shaped (SP)	30907 M104	-

TECHNICAL DATA DATOS TÉCNICOS

	DIN 51130	DIN 51097	UNE-41901 EX	BS 7976-2 (PTV)	ANSI A137.1 (DCOF)
Shaped (SP)	R10	A + B	Class 2	+36 Wet	>0,42

SPECIAL PIECES PIEZAS ESPECIALES

Porcelain Porcelánico (10 mm)

D. TRIANGLE 29x29 cm 11.4x11.4 *			
	WHITE	Shaped (SP)	31302 U58
	DOLPHIN	Shaped (SP)	31296 U58
	MAPLE	Shaped (SP)	31299 U58
	TAUPE	Shaped (SP)	31301 U58
	HONEY	Shaped (SP)	31297 U58
	KALUA	Shaped (SP)	31298 U58
	PORTO	Shaped (SP)	31300 U58

Porcelain Porcelánico (10 mm)

D. TANGRAM 30x30 cm 11.8x11.8 *			
	WHITE	Shaped (SP)	31176 U53
	DOLPHIN	Shaped (SP)	31171 U53
	MAPLE	Shaped (SP)	31173 U53
	TAUPE	Shaped (SP)	31175 U53
	HONEY	Shaped (SP)	31172 U53
	KALUA	Shaped (SP)	31306 U53
	PORTO	Shaped (SP)	31174 U53

Porcelain Porcelánico (10 mm)

* D. ARR 1 9,6x44,9 cm 5.9x13.6 *			
	WHITE	Shaped (SP)	31184 U51
	DOLPHIN	Shaped (SP)	31178 U51
	MAPLE	Shaped (SP)	31181 U51
	TAUPE	Shaped (SP)	31183 U51
	HONEY	Shaped (SP)	31180 U51
	KALUA	Shaped (SP)	31303 U51
	PORTO	Shaped (SP)	31182 U51

Porcelain Porcelánico (10 mm)

* D. ARR 2 9,6x44,9 cm 5.9x13.6 *			
	WHITE	Shaped (SP)	31205 U51
	DOLPHIN	Shaped (SP)	31179 U51
	MAPLE	Shaped (SP)	31202 U51
	TAUPE	Shaped (SP)	31203 U51
	HONEY	Shaped (SP)	31201 U51
	KALUA	Shaped (SP)	31304 U51
	PORTO	Shaped (SP)	31204 U51

Porcelain Porcelánico (10 mm)

TRAP. 34,1x14,7 cm 13.4x5.8 *			
	WHITE	Shaped (SP)	31164 U34
	DOLPHIN	Shaped (SP)	31159 U34
	MAPLE	Shaped (SP)	31161 U34
	TAUPE	Shaped (SP)	31163 U34
	HONEY	Shaped (SP)	31160 U34
	KALUA	Shaped (SP)	31305 U34
	PORTO	Shaped (SP)	31162 U34

COMPLEMENTARY PIECES PIEZAS COMPLEMENTARIAS

S.K.I. S.K.D.



8x30 cm
3.1x11.8 "

Shaped (SP)

U53

SKIRTING

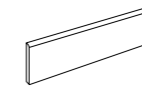

8x75,5 cm
3.1x29.7 "

Shaped (SP)

U43

STAIR TREADS

TECHNICAL (PT)

SEAMLESS (PL/18)

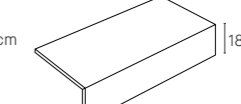
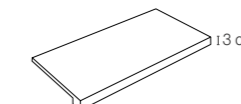

30x151 cm
11.8x59.4 "

U86

U75



12. ■ D. GROW WHITE ARR.1 SP/9,6X44,9/R & D. GROW WHITE ARR.2 SP/9,6X44,9/R

HAUTE

HAUTE is a collection inspired by well-known *Arabescato Vagli* marble from northern Italy. It stands out for its dazzling white background, strewn with grey veins with the occasional sandy hue, all ensuring a chic stylish elegance.

Available in Polished or Shaped finish in a 100x275 cm, 100x180 cm, 100x100 cm, 75.5x151 cm or 60x120 cm format; the collection also features a complementary 33.3x100 cm micro-textured wall tiles in a Shaped finish.

La colección HAUTE se inspira en el conocido mármol *Arabescato Vagli* que tiene su origen en el norte de Italia. Su gráfica se caracteriza por un fondo particularmente blanco, con vetado gris, y ciertos matices en tonalidad arena, que le confieren gran estilo y elegancia.

Disponible en acabados Polished y Shaped, y en formatos 100x275 cm, 100x180 cm, 100x100 cm, 75,5x151 cm y 60x120 cm. Además, se complementa con el revestimiento 33,3x100 cm Shaped.



COLOURS

WHITE



FINISHES

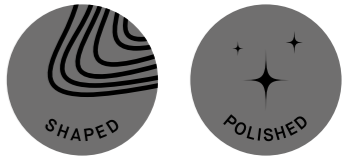

FORMATS

Special Pieces Piezas Especiales

TRAP.	D. MIX	D. CHEVRON	D. TRIANGLE
34,1x14,7 cm 13.4x5.8 "	30x30 cm 11.8x11.8 "	30x21,9 cm 11.8x8.6 "	White Body 29x29 cm 11.4x11.4 "

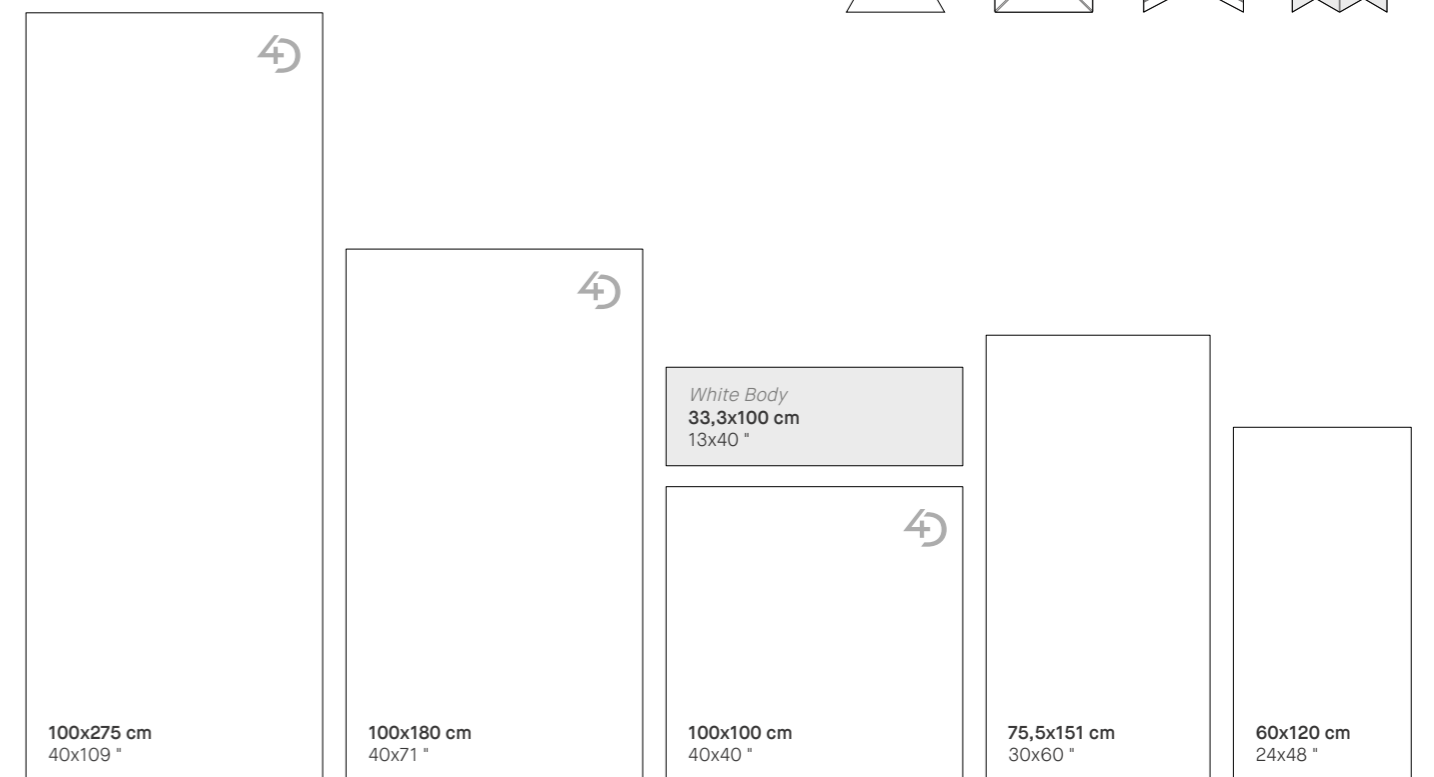

- 01. ■ HAUTE WHITE 75,5X151/EP
- 02. ■ HAUTE WHITE SP/60X120/R ■ GROW PORTO SP/24X151/R
- 03. ■ HAUTE WHITE DECOR SP/33X100/R ■ HAUTE WHITE SP/100X100/R
- 04. ■ HAUTE WHITE SP/60X120/R
- 05. HAUTE WHITE close-up

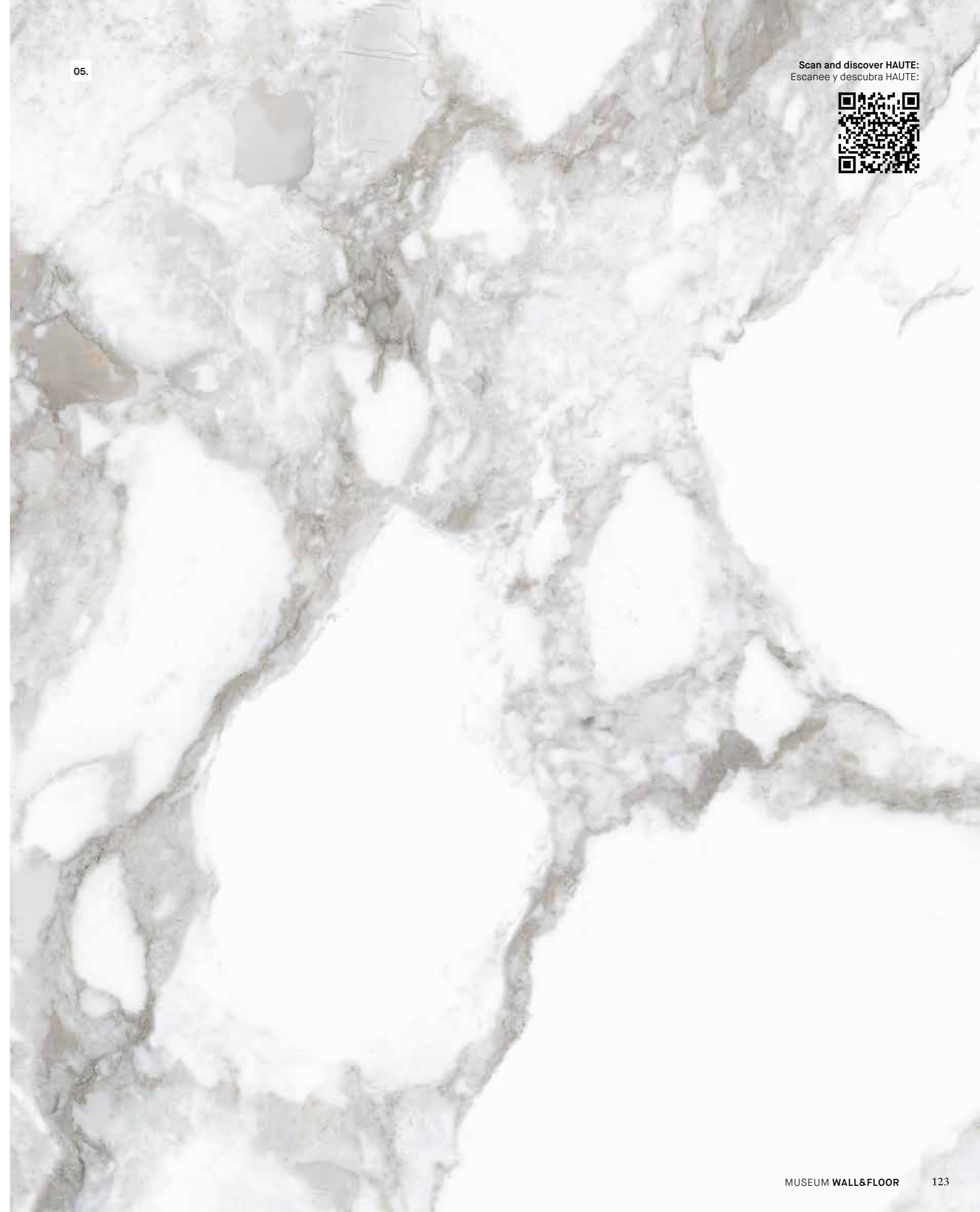
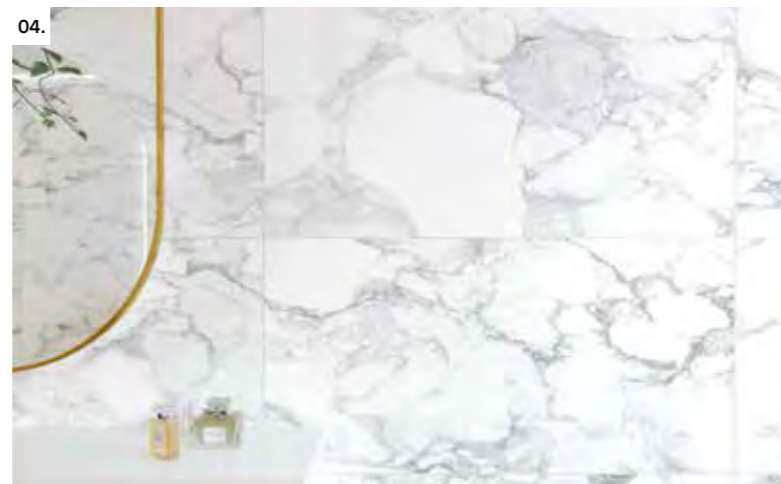

Scan and discover HAUTE:
Escanee y descubra HAUTE:



06.



06. ■ HAUTE WHITE SP/100X275/R ■ GROW TAUPE SP/24X151/R

07. HAUTE WHITE SP

07.





09.



- 08. ■ & ■ HAUTE WHITE SP/100X180/R
- 09. ■ HAUTE WHITE DECOR SP/33X100/R
- 10. ■ HAUTE WHITE DECOR SP/33X100/R

10.





PATTERNS VARIETY VARIEDAD GRÁFICA HAUTE WHITE 100x180 cm FORMAT HAUTE WHITE FORMATO 100x180 cm

FORMATS FORMATOS

		Porcelain Porcelánico				White Body Pasta Blanca		
		100x275 cm 40x109 "	100x180 cm 40x71 "	100x100 cm 40x40 "	75,5x151 cm 30x60 "	60x120 cm 24x48 "	33,3x100 cm 13x40 "	33,3x100 cm 13x40 " * DECOR
Thickness Espesor		6 mm	8 mm		10 mm		10,5 mm	
Patterns Gráficas		6	12	12	16	25	24	24
WHITE	Shaped (SP)	36882 M100	31006 M94	31007 M93	31005 M103	31001 M101	31051 M96	31052 M97
	Polished (EP)	-	-	-	31000 M58	30996 M40	-	-

* Coordinated installation:
make sure the textured face is
looking downwards.
* Colocación entre piezas:
recomendable colocar la
textura hacia abajo.

TECHNICAL DATA DATOS TÉCNICOS

	DIN 51130	DIN 51097	UNE-41901 EX	BS 7976-2 (PTV)	ANSI A137.1 (DCOF)
Shaped (SP) 6-8 mm	-	-	Class 1	-	>0,42
Shaped (SP) 10 mm	R10	A + B	Class 2	+36 Wet	>0,42

SPECIAL PIECES PIEZAS ESPECIALES

Porcelain Porcelánico (10 mm)

D. MIX 30x30 cm 11.8x11.8 "			
	HAUTE WHITE HAUTE WHITE STROND DOLPHIN	Shaped (SP) Polished (EP) Shaped (SP)	31148 U51



Porcelain Porcelánico (10 mm)

TRAP. 34,1x14,7 cm 13.4x5.8 "			
	WHITE	Shaped (SP)	31146 U34
		Polished (EP)	31147 U34

White Body Pasta Blanca (10,5 mm)

** D. TRIANGLE 29x29 cm 11.4x11.4 "			
	WHITE	Shaped (SP)	31149 U55

Porcelain Porcelánico (10 mm)

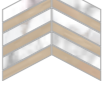
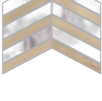
D. CHEVRON 30x21,9 cm 11.8x8.6 "			
	HAUTE WHITE GROW KALUA	Shaped (SP) Shaped (SP)	31155 U51
	HAUTE WHITE GROW KALUA	Polished (EP) Shaped (SP)	31152 U51
	HAUTE WHITE GROW TAUPE	Shaped (SP) Shaped (SP)	31154 U51
	HAUTE WHITE GROW TAUPE	Polished (EP) Shaped (SP)	31151 U51

* Random colour position.
* Posición de colores aleatoria.

** Only suitable for wall installations.
** Adecuado únicamente como revestimiento.

COMPLEMENTARY PIECES PIEZAS COMPLEMENTARIAS

S.K.I. S.K.D.



8x30 cm
3.1x11.8 "

SKIRTING

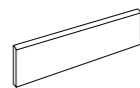

8x100 cm 3.1x39.4 "
8x75,5 cm 3.1x29.7 "
8x60 cm 3.1x23.6 "

Shaped (SP)	U53	Shaped (SP)	U45	U43	U35
Polished (EP)	U53	Polished (EP)	-	U43	U35

STAIR TREADS

TECHNICAL (PT) SEAMLESS (PL/18)

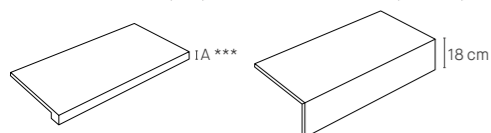

30x180 cm 11.8x70.8 "
30x151 cm 11.8x59.4 "
30x120 cm 11.8x47.2 "
30x100 cm 11.8x39.4 "
30x75,5 cm 11.8x29.7 "
30x60 cm 11.8x23.6 "

Shaped (SP)	U90	U86	U75	U74	U76	U54
Polished (EP)	-	U86	U75	-	U76	U54

*** When thickness is 6 mm, A = 18 mm;
when 8 mm, then A = 24 mm;
when 10 mm, then A = 30 mm.
*** Cuando el espesor es 6 mm, A = 18 mm;
cuando es 8 mm, A = 24 mm;
cuando es 10 mm, A = 30 mm.

11. ■ D. HAUTE WHITE/TAUPE CHEVRON SP/30X21,9



IRON 4D

IRON is inspired by *Weathering* steel and its metamorphosis, with a unique design further enriched by the application of the new 4D Shaped technology.

The collection comes in two colours: Denim and Oxide. This first emulates the dark blue tones of new weathering steel with some patches of rust, while Oxide stands out for its copper tones, dotted with small bluish-black patches. Both colours can be used individually to stylish elegant effect or else combined.

Iron comes in a 4D TECH 180x100 cm or 100x100 cm format, conceived to dress up living spaces of all kinds in exquisite modern fashion.

IRON es la colección que se inspira en el acero *Corten* evolucionado. Su diseño único se ve potenciado por la nueva tecnología 4D Shaped.

Representado en dos versiones de color: Denim y Oxide. El color Denim tiene el tono azul oscuro del corte original, con algunas zonas oxidadas, mientras que en el color Oxide abundan los tonos cobrizos junto con pequeñas zonas negras azuladas. Ambos son tonos perfectamente combinables entre sí, y que poseen estilo y elegancia por sí solos.

Iron se presenta en gran formato 4D TECH: 180x100 cm y 100x100 cm, que permiten decorar cualquier espacio, convirtiéndolo en exquisito y contemporáneo.



COLOURS

DENIM



OXIDE



FINISHES



FORMATS

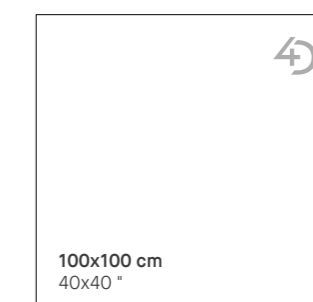
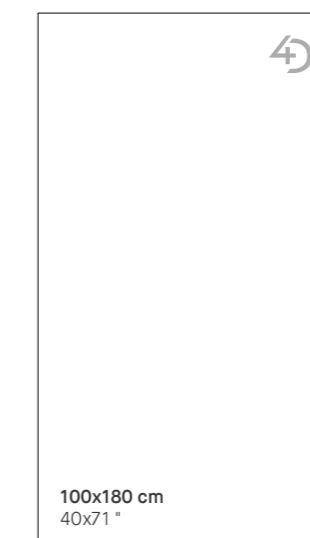

Special Pieces Piezas Especiales

D. IRON

30x50 cm
11.8x19.7"

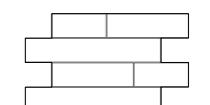

- 01. ■ IRON OXIDE SP/100X180/R ■ D.IRON OXIDE SP/30X50
- 02. ■ IRON DENIM SP/100X180/R
- 03. IRON DENIM SP in "Villa Indira" exclusive bathroom, located in Rhodes, Greece. In collaboration with Komissa Giorgoudiou. Photography: George Pagonakis
- 04. ■ IRON OXIDE SP/100X100/R & IRON OXIDE SP'
- 05. IRON OXIDE close-up



05.

Scan and discover IRON 4D:
Escanee y descubra IRON 4D:





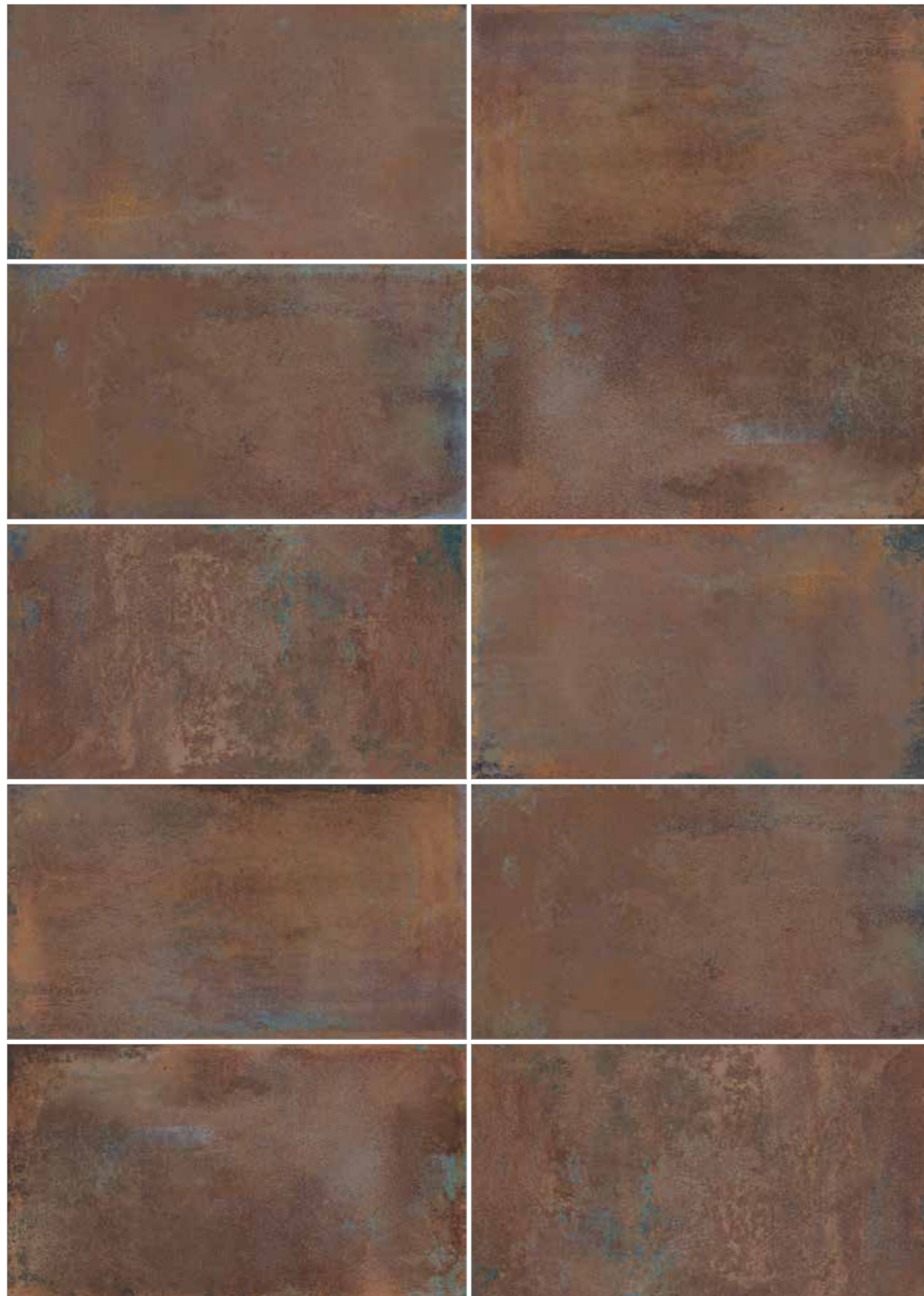

PATTERNS VARIETY VARIEDAD GRÁFICA IRON OXIDE 100x180 cm FORMAT IRON OXIDE FORMATO 100x180 cm



FORMATS FORMATOS

		Porcelain Porcelánico	
		100x180 cm 40x71"	100x100 cm 40x40"
Thickness Espesor		8 mm	
Patterns Gráficas		5	10
OXIDE	Shaped (SP)	28723 M94	28726 M93
	Shaped (SP)	28724 M94	28725 M93

SPECIAL PIECES PIEZAS ESPECIALES

Porcelain Porcelánico (8 mm)



* D. IRON 30x50 cm 11.8x19.7"

	OXIDE	Shaped (SP)	29169 U64
	DENIM	Shaped (SP)	29168 U64

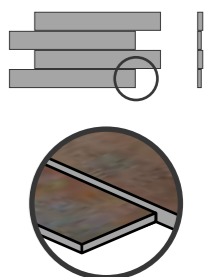
* D. IRON combines cuts with different heights: low pieces are 8 mm and high ones are elevated to 11 mm.
* D. HORIZON combina cortes a distintas alturas: las piezas bajas son 8 mm y las altas se elevan hasta los 11 mm.

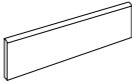
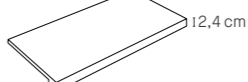

COMPLEMENTARY PIECES PIEZAS COMPLEMENTARIAS

S.K.I. S.K.D.		SKIRTING		STAIR TREADS	
				TECHNICAL (PT)	SEAMLESS (PL/18)
	8x30 cm 3.1x11.8"		8x100 cm 3.1x39.4"		
Shaped (SP)	U53	Shaped (SP)	U45	12,4 cm	18 cm
				30x180 cm 11.8x70.8"	30x100 cm 11.8x39.4"
				Shaped (SP)	U90 U74

TECHNICAL DATA DATOS TÉCNICOS

	DIN 51130	DIN 51097	UNE-41901 EX	BS 7976-2 (PTV)	ANSI A137.1 (DCOF)
Shaped (SP)	-	-	Class 1	-	>0,42

KRON 4D

KRON 4D is inspired by an exquisite natural stone, with a neutral background whose crisscrossing fine white veins guarantee a unique stylish elegance.

The collection comes in a choice of two different shades of grey: Gray, which is perfect to create restful settings, and Charcoal, a darker option for spaces with added personality. The collection comes in a 100x275 cm format in a Natural finish.

KRON 4D se inspira en una exquisita piedra natural, en la cual se entrecruzan finas vetas blancas sobre su fondo neutro, que aportan un estilo único y elegante.

Su gama cromática se compone de dos tonos grises. Gray, un tono claro perfecto para crear espacios calmados, y Charcoal, una opción que aporta mayor carácter gracias a su intensidad de negro. La colección se presenta en 100x275 cm, en acabado Natural.



COLOURS

GRAY



CHARCOAL







FINISHES

NATURAL

FORMATS



100x275 cm
40x109 "

- 01.  &  KRON GRAY NT/100x275/R
- 02.  KRON CHARCOAL NT/100x275/R
- 03. KRON CHARCOAL NT/100x275/R in the private housing Ca'rabasseta designed by Dobleese Estudio. Photography: María Mira.
- 04.  KRON GRAY NT/100x275/R
- 05. KRON GRAY close-up





Scan and discover KRON 4D:
Escanee y descubra KRON 4D:







FORMATS FORMATOS

		Porcelain Porcelánico
		100x275 cm 40x109 "
Thickness Espesor		6 mm
Patterns Gráficas		4
	GRAY Natural (NT)	36879 M89
	CHARCOAL Natural (NT)	36127 M89

PATTERNS VARIETY VARIEDAD GRÁFICA KRON GRAY 100x275 cm FORMAT KRON GRAY FORMATO 100x275 cm

LAKESTONE

LAKESTONE, as its name indicates, is inspired by the stones found in lakes. This collection emulates an eye-catching sandstone, with a varying grainy appearance and colour. Its varying design brings a sense of movement to surfaces, combined with a neutral-coloured warmth synonymous with the natural world.

The tiles come in an All in One finish in a choice of three colours —Cloud, Oat and Dolphin— and formats: 60x120 cm, 90x90 cm, plus a 33x100 cm wall tile model in a Natural finish.

LAKESTONE, como su nombre indica, está inspirada en las piedras que se obtienen en los lagos. Esta colección se caracteriza por ser una preciosa arenisca de grano variado en tamaño y color. Su gran diversidad gráfica aporta movimiento en conjunto, y una calidez neutra muy propia de la naturaleza.

Disponible en acabado All in One. En tres colores —Cloud, Oat y Dolphin— y con formatos 60x120 cm, 90x90 cm y un revestimiento de 33x100 cm en acabado Natural.



COLOURS

CLOUD



OAT



DOLPHIN



FINISHES



FORMATS

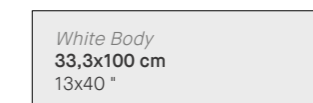
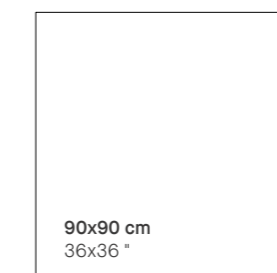
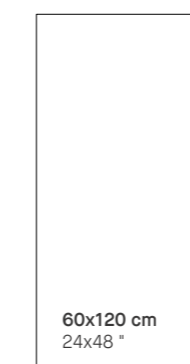

Special Pieces Piezas Especiales

D. MIX

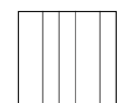

30x30 cm
11.8x11.8"

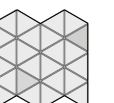

D. TRIANGLE

White Body
29x29 cm
11.4x11.4"



- 01.  LAKESTONE CLOUD AS/60x120/C/R
- 02.  LAKESTONE OAT AS/75,5X151/C/R
- 03. LAKESTONE CLOUD AS
- 04. LAKESTONE CLOUD close-up



Scan and discover LAKESTONE:
Escanee y descubra LAKESTONE:











PATTERNS VARIETY VARIEDAD GRÁFICA LAKESTONE OAT 60x120 cm FORMAT LAKESTONE OAT FORMATO 60x120 cm

FORMATS FORMATOS

		Porcelain Porcelánico		White Body Pasta Blanca	
		60x120 cm 24x48 "	90x90 cm 36x36 "	33,3x100 cm 13x40 "	33,3x100 cm 13x40 "
				DECOR	
Thickness Espesor		10 mm		10,5 mm	
Patterns Gráficas		11	9	8	6
CLOUD	All in One (AS)	28543 M91	28546 M81	-	-
	Natural (NT)	-	-	28574 M82	28573 M83
OAT	All in One (AS)	28544 M91	28547 M81	-	-
DOLPHIN	All in One (AS)	28545 M91	28548 M81	-	-

TECHNICAL DATA DATOS TÉCNICOS

	DIN 51130	DIN 51097	UNE-41901 EX	BS 7976-2 (PTV)	ANSI A137.1 (DCOF)
All in One (AS)	R11	A + B + C	Class 3	+36 Wet	>0,42
	60x120 cm 24x48 "	90x90 cm 36x36 "		33,3x100 cm 13x40 "	
All in One (AS)	U4 P3 E3 C2	U4 P3 E3 C2	Natural (NT)	E3 C2	

SPECIAL PIECES PIEZAS ESPECIALES

Porcelain Porcelánico (10 mm)

D. MIX	30x30 cm 11.8x11.8 "		
	LAKESTONE CLOUD, OAT & DOLPHIN	All in One (AS)	29164 U49

White Body Pasta Blanca (10 mm)

* D. TRIANGLE	29x29 cm 11.4x11.4 "		
	CLOUD	Natural (NT)	29223 U55

* Only suitable for wall installations.
* Adecuado únicamente como revestimiento.

POOL PIECES PIEZAS DE PISCINA

Porcelain Porcelánico

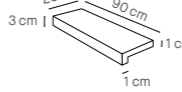
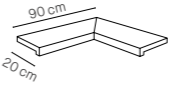
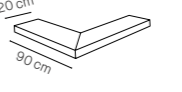
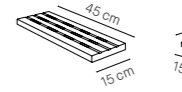
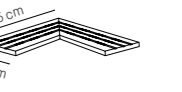
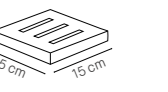
					
P.V. (POOL COPING)	ANG.P.V. (POOL COPING INTERNAL CORNER)	E.P.V. (POOL COPING EXTERNAL CORNER)	REJ. (DRAINAGE GRATE)	ANG.REJ. (ANGLE CORNER DRAINAGE GRATE)	T.REJ. (SQUARE CORNER DRAINAGE GRATE)
20x90x1 cm 8x35.4x0.4 "	90x90x1 cm 35.4x35.4x0.4 "	90x90x1 cm 35.4x35.4x0.4 "	15x45x2,3 cm 6x17.7x0.9 "	45x45x2,3 cm 17.7x17.7x0.9 "	15x15x2,3 cm 6x6x0.9 "

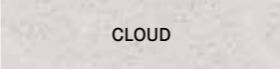
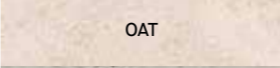
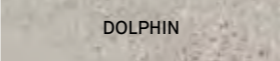
	All in One (AS)	29996 U81	30003 U75	30006 U75	30009 U54	30012 U75	30015 U71
	All in One (AS)	30001 U81	30004 U75	30008 U75	30011 U54	30013 U75	30017 U71
	All in One (AS)	30002 U81	30005 U75	30007 U75	30010 U54	30014 U75	30016 U71

COMPLEMENTARY PIECES PIEZAS COMPLEMENTARIAS

S.K.I. S.K.D.

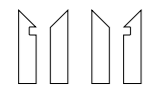

8x30 cm
3.1x11.8 "

All in One (AS)

U53

SKIRTING

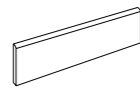

8x90 cm
3.1x35.4 "

All in One (AS)

U44

8x60 cm
3.1x23.6 "

U35

STAIR TREADS

TECHNICAL (PT)

SEAMLESS (PL/18)

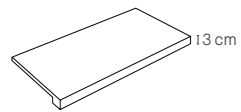

13 cm

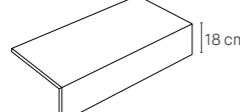

18 cm

30x120 cm
11.8x47.2 "

30x90 cm
11.8x35.4 "

30x60 cm
11.8x23.6 "

All in One (AS)

U75

U76

U54



07. ■ LAKESTONE CLOUD DECOR/33,3X100/R

LUMINA

LUMINA is a soft-coloured collection inspired by the semi-precious stone, onyx. This is a unique collection, with the mirror-like shine characteristic of MUSEUM's glazed porcelain tiles, suitable for all kinds of living spaces.

Now it comes in a 75,5x151 cm or 60x120 cm formats.

La colección LUMINA, inspirada en el ónice, representa una piedra semipreciosa sobre una paleta de color suave, que junto con el alto brillo característico del porcelánico esmaltado pulido MUSEUM, la convierten en una colección única para todo tipo de ambientes.

Actualmente, se encuentra disponible en los formatos 75,5x151 cm y 60x120 cm.



COLOURS

ICE





FINISHES

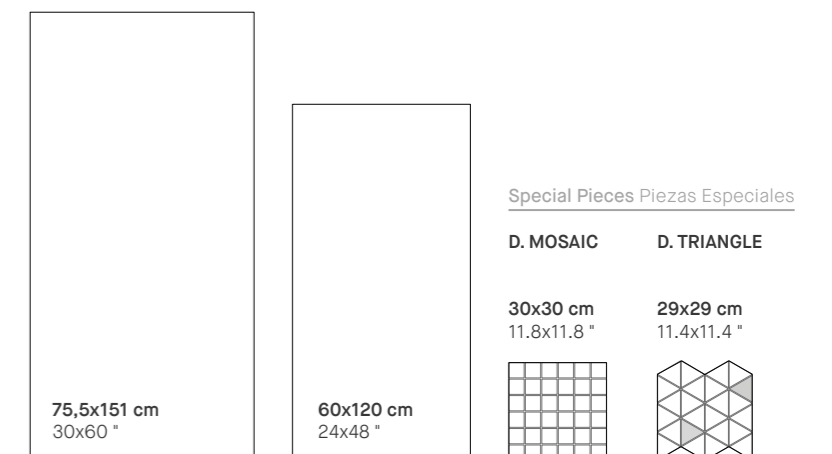

FORMATS



- 01.  LUMINA ICE/75,5X151/EP
- 02.  LUMINA ICE/60X120/EP
- 03. LUMINA /75,5X151/EP in "Villa Indira" exclusive housing in Rhodes, Greece. In collaboration with Komissa Giorgoudiou. Photography: George Pagonakis
- 04.  LUMINA ICE/75,5X151/EP
- 05. LUMINA ICE close-up

Scan and discover LUMINA:
Escanee y descubra LUMINA:





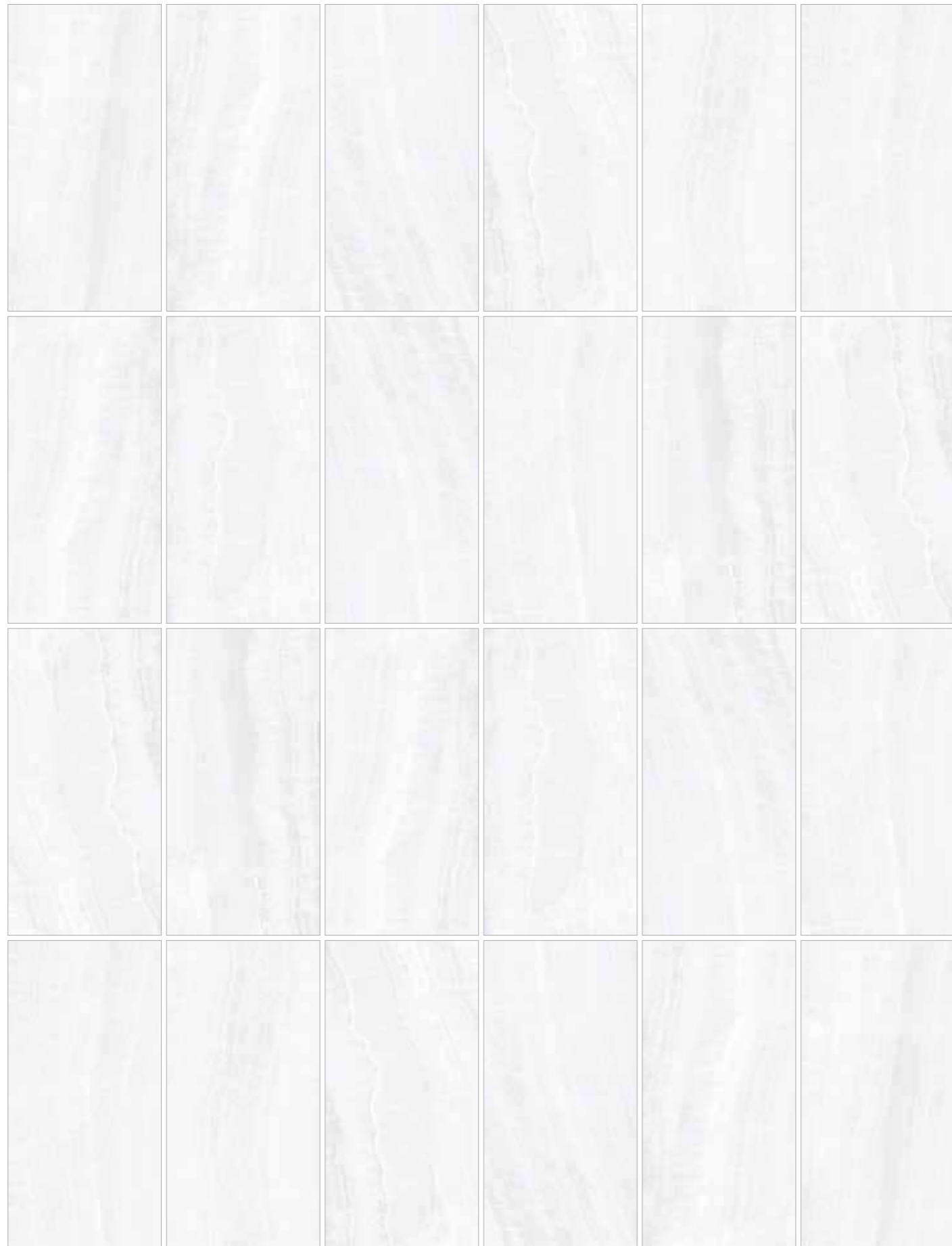



PATTERNS VARIETY VARIEDAD GRÁFICA LUMINA ICE 60x120 cm FORMAT LUMINA ICE FORMATO 60x120 cm

FORMATS FORMATOS

		Porcelain Porcelánico	
		75,5x151 cm 30x60 "	60x120 cm 24x48 "
Thickness Espesor		10 mm	
Patterns Gráficas		12	9
	Polished (EP)	25579 M58	25703 M40

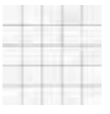
SPECIAL PIECES PIEZAS ESPECIALES

Porcelain Porcelánico (10 mm)				Porcelain Porcelánico (10 mm)			
D. MOSAIC		30x30 cm 11.8x11.8 "		D. TRIANGLE		29x29 cm 11.4x11.4 "	
	ICE	Polished (EP)	26358 U49		ICE	Polished (EP)	26357 U58

* Only suitable for wall installations.
* Adecuado únicamente como revestimiento.

COMPLEMENTARY PIECES PIEZAS COMPLEMENTARIAS

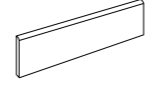
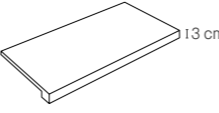
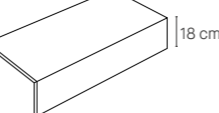
S.K.I. S.K.D.		SKIRTING			
	8x30 cm 3.1x11.8 "		8x75,5 cm 3.1x29.7 "	8x60 cm 3.1x23.6 "	
Polished (EP)	U53	Polished (EP)	U43	U35	
STAIR TREADS					
TECHNICAL (PT)		SEAMLESS (PL/18)			
	13 cm		18 cm	30x151 cm 11.8x59.4 "	30x120 cm 11.8x47.2 "
				30x75,5 cm 11.8x29.7 "	30x60 cm 11.8x23.6 "
		Polished (EP)		U86	U75
				U76	U54

MAINSTONE

MAINSTONE is a porcelain tile collection inspired by more soothing versions of *Breccia* stone. It stands out particularly for its well-balanced shades, with a distinctive subtle pattern that lends it a modern and elegant appeal.

Comes in a Natural or Antislip finish in four particular warm colours: Cloud, Oat, Dolphin & Moon. It is available in a 75.5x151 cm, 60x120 cm or 90x90 cm format.

MAINSTONE es una colección de porcelánico, inspirada en una *Breccia* calmada, que se caracteriza principalmente por una estética compensada a nivel tono, y diferenciada de forma sutil por un ligero veteado, que le proporciona un carácter moderno y elegante al mismo tiempo.

Se encuentra disponible en acabado Natural o Antislip, sobre una variedad cromática con especial aporte cálido, diferenciados en cuatro tonos: Cloud, Oat, Dolphin y Moon. Se presenta en los formatos 75,5x151 cm, 60x120 cm y 90x90 cm.



COLOURS



FINISHES

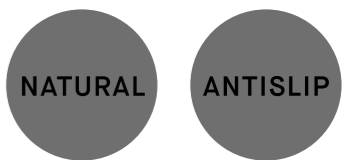

FORMATS

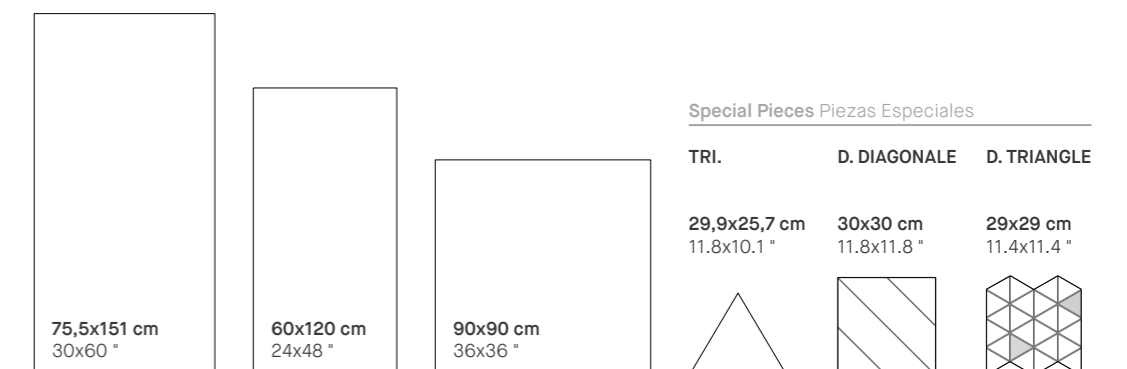

- 01. ■ MAINSTONE MOON NT/60X120
- 02. ■ MAINSTONE CLOUD NT/75,5X151/R
- 03. ■ D. MAINSTONE MIX TANGRAM NT/30X30/C
- 04. MAINSTONE MOON NT
- 05. MAINSTONE DOLPHIN close-up

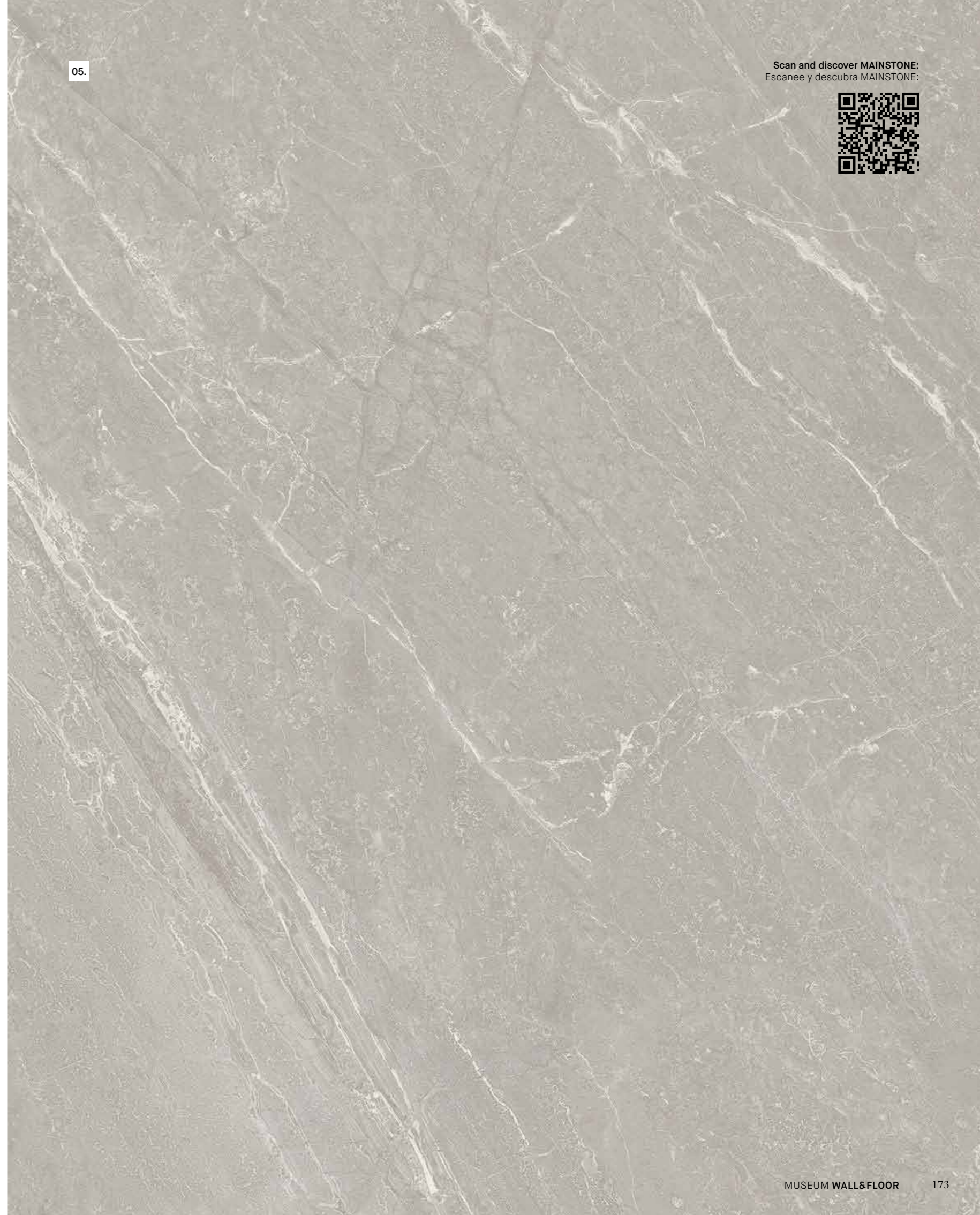

Scan and discover MAINSTONE:
Escanee y descubra MAINSTONE:









PATTERNS VARIETY VARIEDAD GRÁFICA MAINSTONE CLOUD 75,5x151 cm FORMAT MAINSTONE CLOUD FORMATO 75,5x151 cm

FORMATS FORMATOS

		Porcelain Porcelánico		
		75,5x151 cm 30x60 "	60x120 cm 24x48 "	90x90 cm 36x36 "
Thickness Espesor		10 mm		
Patterns Gráficas		12	16	8
CLOUD	Natural (NT)	27835 M59	27250 M66	27258 M68
	Antislip (A)	-	-	27819 M81
OAT	Natural (NT)	27838 M59	27251 M66	27257 M68
	Antislip (A)	-	-	27829 M81
DOLPHIN	Natural (NT)	27836 M59	27249 M66	27259 M68
	Antislip (A)	-	-	27828 M81
MOON	Natural (NT)	27837 M59	27248 M66	27256 M68
	Antislip (A)	-	-	27830 M81





TECHNICAL DATA DATOS TÉCNICOS

	DIN 51130	DIN 51097	UNE-41901 EX	BS 7976-2 (PTV)	ANSI A137.1 (DCOF)
Natural (NT) 10 mm	R10	-	Class 2	+36 Wet	>0,42
Antislip (A)	R11	A + B + C	Class 3	+36 Wet	>0,42



	60x120 cm 24x48 "	90x90 cm 36x36 "
Natural (NT) 10 mm	U4 P3 E3 C2	U4 P3 E3 C2

SPECIAL PIECES PIEZAS ESPECIALES

Porcelain Porcelánico (10 mm)

TRI.	29,9x25,7 cm 11.8x10.1 "		
	CLOUD	Natural (NT)	27847 U34
	OAT	Natural (NT)	27849 U34
	DOLPHIN	Natural (NT)	27850 U34
	MOON	Natural (NT)	27851 U34

Porcelain Porcelánico (10 mm)

* D. TRIANGLE	29x29 cm 11.4x11.4 "		
	CLOUD	Natural (NT)	35287 U58
	OAT	Natural (NT)	35309 U58
	DOLPHIN	Natural (NT)	35288 U58
	MOON	Natural (NT)	35289 U58

Porcelain Porcelánico (10 mm)

D. TANGRAM	30x30 cm 11.8x11.8 "		
	MAINSTONE MIX CLOUD, OAT, DOLPHIN & MOON	Natural (NT)	27884 U53

COMPLEMENTARY PIECES PIEZAS COMPLEMENTARIAS

S.K.I. S.K.D.

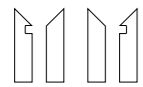

8x30 cm
3.1x11.8 "

SKIRTING

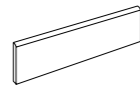

8x90 cm 3.1x35.4 "
8x75,5 cm 3.1x29.7 "
8x60 cm 3.1x23.6 "

Natural (NT)	U53	Natural (NT)	U44	U43	U35
Antislip (A)	U53	Antislip (A)	U44	-	-

STAIR TREADS

TECHNICAL (PT) SEAMLESS (PL/18)

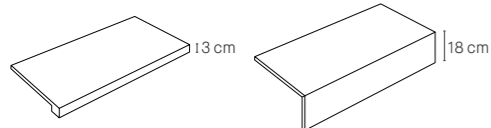

30x151 cm 11.8x59.4 "
30x120 cm 11.8x47.2 "
30x90 cm 11.8x35.4 "
30x75,5 cm 11.8x29.7 "
30x60 cm 11.8x23.6 "

Natural (NT)	U80	U75	U76	U70	U54
Antislip (A)	-	-	U76	-	-

POOL PIECES PIEZAS DE PISCINA

Porcelain Porcelánico

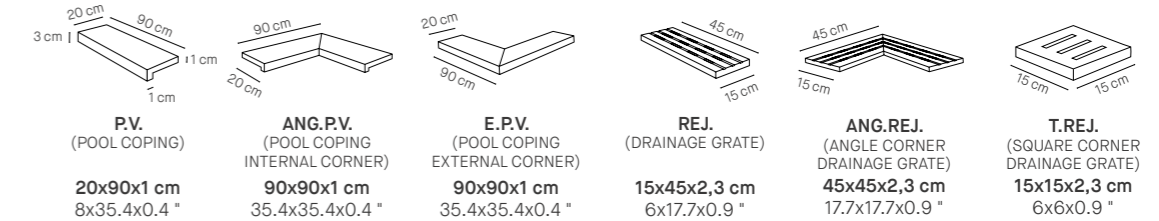

CLOUD	Antislip (A)	27907 U81	27911 U75	27915 U75	27923 U54	27927 U75	27928 U71
OAT	Antislip (A)	27908 U81	27912 U75	27922 U75	27926 U54	27934 U75	27931 U71
DOLPHIN	Antislip (A)	27909 U81	27913 U75	27920 U75	27924 U54	27932 U75	27929 U71
MOON	Antislip (A)	27910 U81	27914 U75	27921 U75	27925 U54	27933 U75	27930 U71

* Only suitable for wall installations.
* Adecuado únicamente como revestimiento.



09. ■ MAINSTONE OAT/90x90/A/R & REJ./15x45/A/C/R

MARQUINA

MARQUINA collection is inspired by the well-known black marble of the same name. Suitable for a wide range of settings, the collection's irregular white veined pattern contrasts with the purity of its black background.

Available in a 60x120 cm or 75,5x151 cm format and a Polished finish, it stands out for its chic elegance.

La colección MARQUINA, inspirada en el conocido mármol negro que le da nombre, es especialmente combinable con todo tipo de ambientes. Sus irregulares vetas blancas contrastan con la pureza de su base negra.

Disponibile en los formatos 60x120 cm y 75,5x151 cm, y en acabado Pulido, destaca por su sofisticación y elegancia.

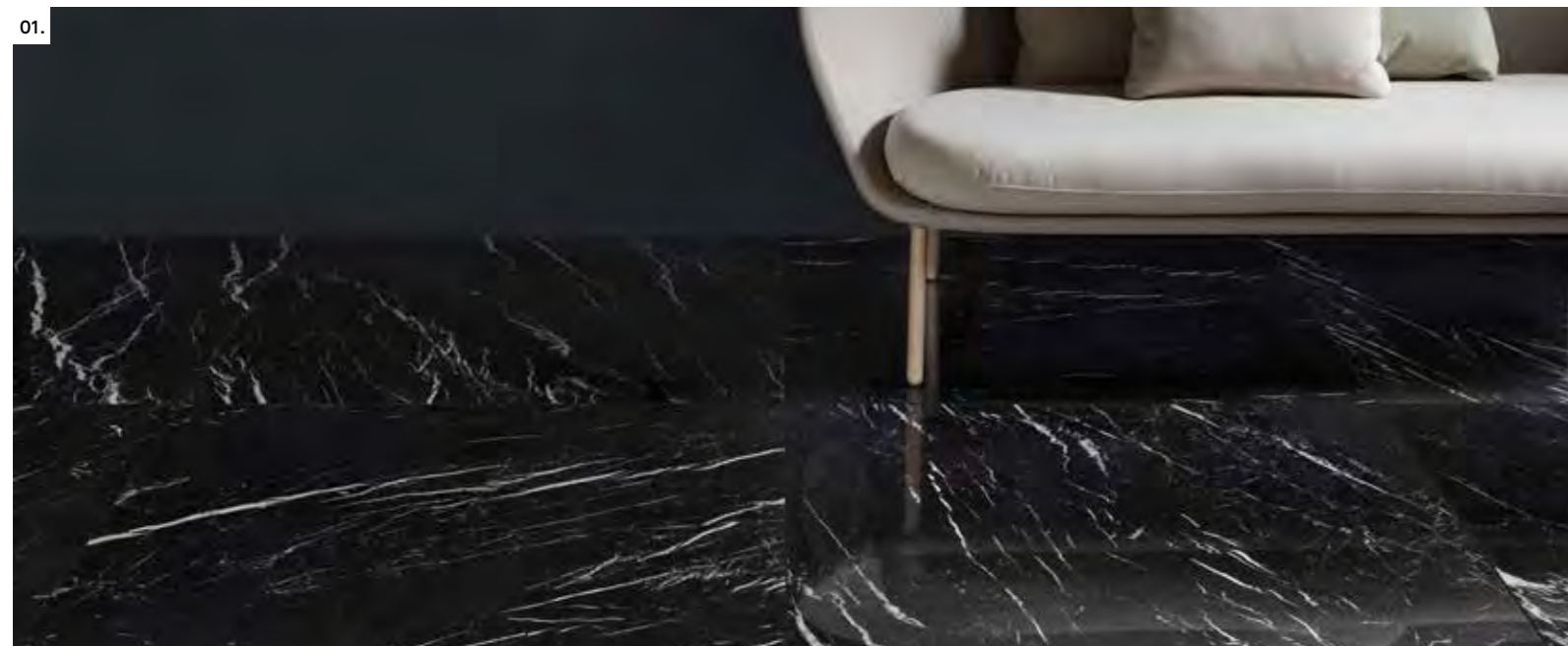

COLOURS

CLOUD



FINISHES

FORMATS

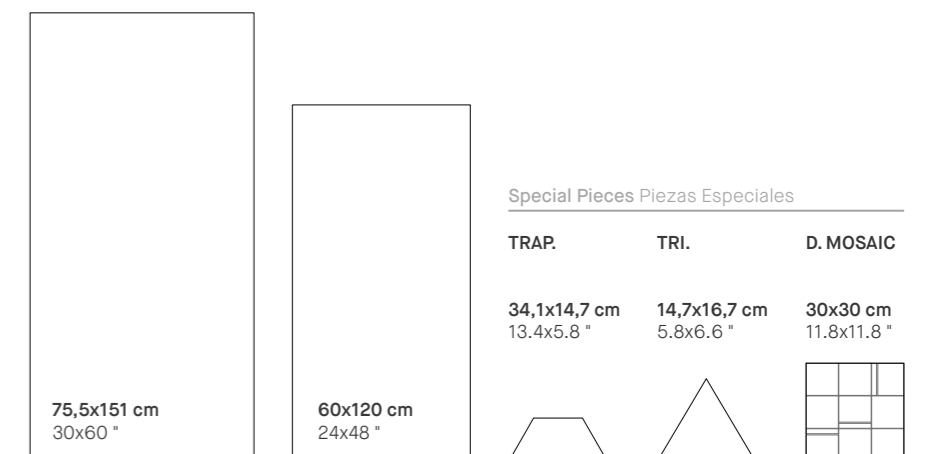

- 01. ■ MARQUINA BLACK/60X120/EP
- 02. 03. Custom cuts of MARQUINA BLACK/60X120/NAT/R and STATUARIO PLUS/60X120/NAT/R at "La Diva" restaurant in Valencia, designed by Proyecto Singular. In collaboration with Grupo Recaba and Toni Mansilla.
- 04. MARQUINA PIEZAS special pieces
- 05. MARQUINA BLACK close-up



Scan and discover MARQUINA:
Escanee y descubra MARQUINA:





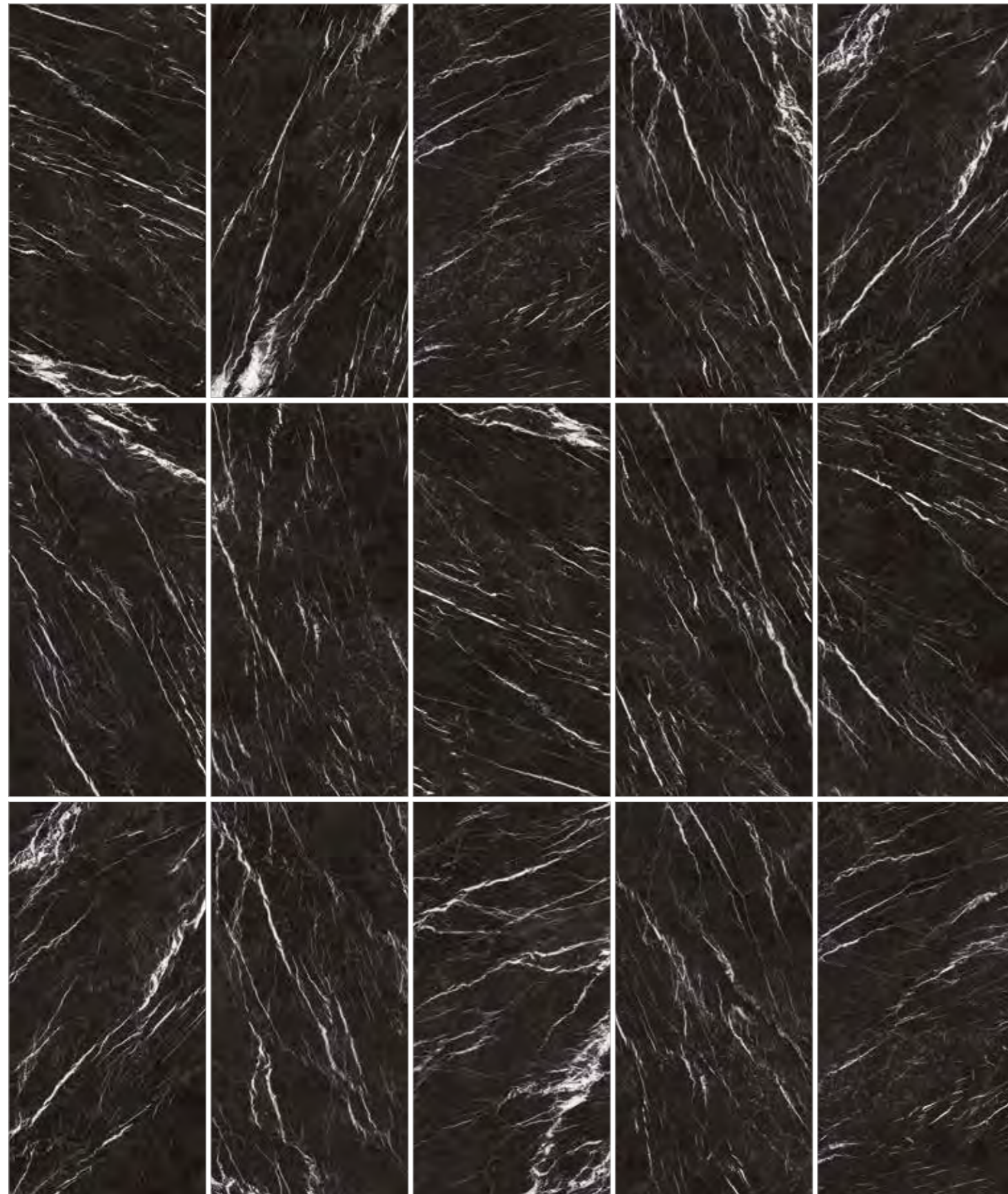

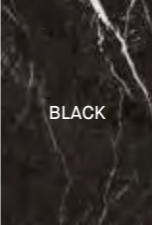

PATTERNS VARIETY VARIEDAD GRÁFICA MARQUINA BLACK 75,5x151 cm FORMAT MARQUINA BLACK FORMATO 75,5x151 cm

FORMATS FORMATOS

		Porcelain Porcelánico	
		75,5x151 cm 30x60"	60x120 cm 24x48"
Thickness Espesor		10 mm	
Patterns Gráficas		12	15
	Polished (EP)	23453 M74	23461 M73

SPECIAL PIECES PIEZAS ESPECIALES

Porcelain Porcelánico (10 mm)				Porcelain Porcelánico (10 mm)			
TRAP.	34,1x14,7 cm 13.4x5.8"			TRI.	14,7x16,7 cm 5.8x6.6"		
	BLACK	Polished (EP)	23563 U28		BLACK	Polished (EP)	23560 U13

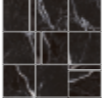
Porcelain Porcelánico (10 mm)			
* D. MOSAIC	30x30 cm 11.8x11.8"		
	BLACK	Polished (EP)	23542 U58

* Only suitable for wall installations.
* Adecuado únicamente como revestimiento.

COMPLEMENTARY PIECES PIEZAS COMPLEMENTARIAS

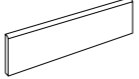
S.K.I. S.K.D.		SKIRTING			
	8x30 cm 3.1x11.8"		8x75,5 cm 3.1x29.7"	8x60 cm 3.1x23.6"	
Polished (EP)	U53	Polished (EP)	U43	U35	

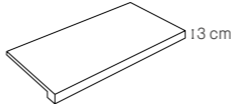
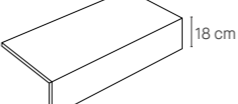
STAIR TREADS					
TECHNICAL (PT)		SEAMLESS (PL/18)			
	13 cm		18 cm	30x151 cm 11.8x59.4"	30x120 cm 11.8x47.2"
				30x75,5 cm 11.8x29.7"	30x60 cm 11.8x23.6"
		Polished (EP)		U86	U75
				U76	U54

ONIX

ONIX's spectacular pattern comes in 75,5x151 cm and 60x120 cm formats, in a unique Polished finish.

Its pattern is inspired by onyx, a semiprecious stone appreciated since ancient times for its eye-catching beauty. Today it is one of the most up-to-the-minute deluxe wall and floor tiles.

ONIX lleva la espectacularidad de su gráfica a los formatos 75,5x151 cm y 60x120 cm, en un único acabado Pulido.

Su gráfica se inspira en la piedra semipreciosa Ónice, valorada como una piedra de valor estético desde la antigüedad. Hoy se posiciona entre los productos más en tendencia para pavimentos y revestimientos lujosos.



COLOURS

PEARL



FINISHES



FORMATS

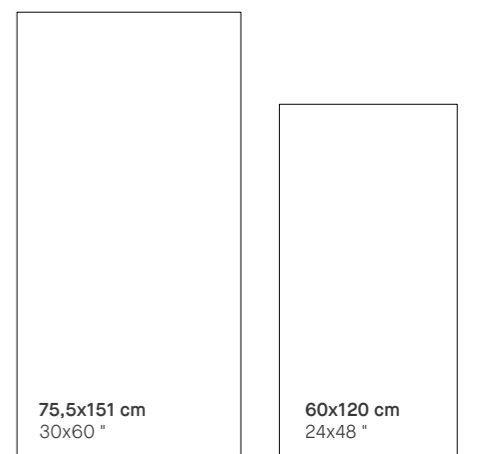

- 01. ■ ONIX PEARL/75,5X151/EP
- 02. ■ ONIX PEARL/75,5X151/EP
- 03. ■ ONIX PEARL/75,5X151/EP
- 04. ONIX PEARL close-up



04.

Scan and discover ONIX:
Escanee y descubra ONIX:





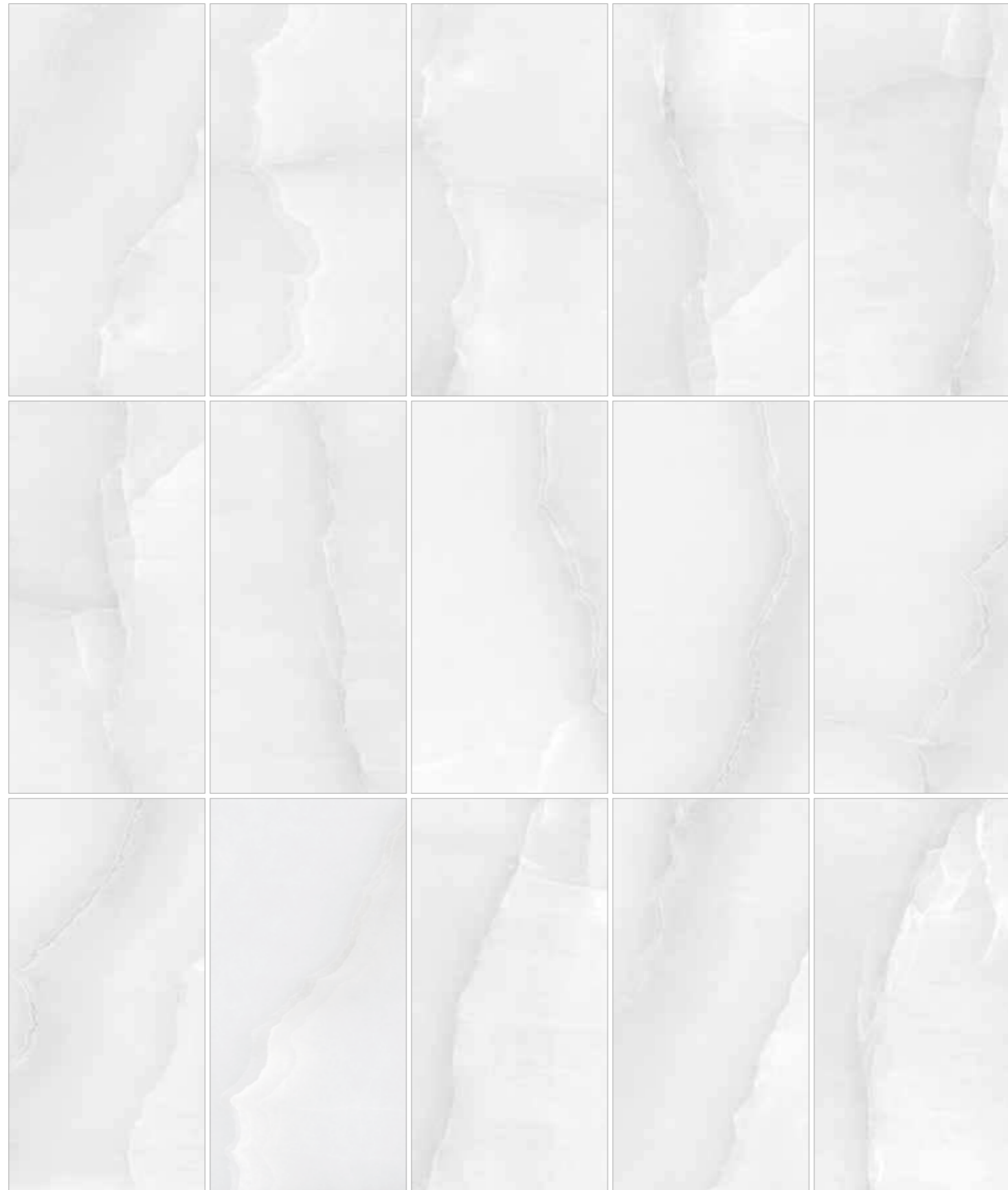

PATTERNS VARIETY VARIEDAD GRÁFICA ONIX PEARL 75,5x151 cm FORMAT ONIX PEARL FORMATO 75,5x151 cm

FORMATS FORMATOS

		Porcelain Porcelánico	
		75,5x151 cm 30x60"	60x120 cm 24x48"
Thickness Espesor		10 mm	
Patterns Gráficas		18	18
	PEARL Polished (EP)	21069 M58	22110 M40

COMPLEMENTARY PIECES PIEZAS COMPLEMENTARIAS

S.K.I. S.K.D.

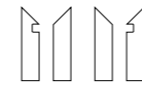

8x30 cm
3.1x11.8"

Polished (EP)

U53

SKIRTING

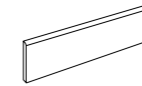

8x75,5 cm 8x60 cm
3.1x29.7" 3.1x23.6"

Polished (EP)

U43

U35

STAIR TREADS

TECHNICAL (PT)

SEAMLESS (PL/18)

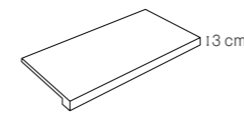

Polished (EP)

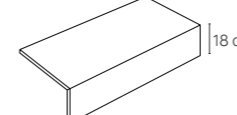

18 cm

30x151 cm 30x120 cm 30x75,5 cm 30x60 cm
11.8x59.4" 11.8x47.2" 11.8x29.7" 11.8x23.6"

U86

U75

U76

U54

OPERA

OPERA's exquisite design is inspired by *cappuccino coffee*, shot with cracked veins, Opera Fumo, is dark anthracite in colour with a distinctive warm allure.

OPERA comes in a unique Polished finish, a mirror-like shine for glazed porcelain tiles, in a choice of two formats: 75.5x151 cm and 60x120 cm. The collection brings a stylish contemporary appeal to living spaces, drawing all attention to the flooring.

Su exquisita gráfica interpreta un capuchino con vetas craqueadas, OPERA Fumo, es un tono antracita muy intenso, pero con un toque cálido y singular.

Su acabado único Pulido, representa el alto brillo en porcelánico esmaltado, en dos versiones de formatos tanto en 75,5x151 cm como en 60x120 cm. Como resultado de su aplicación, se obtienen espacios contemporáneos y verdaderamente estilosos, donde el pavimento es el protagonista por excelencia.



COLOURS

FUMO





FINISHES

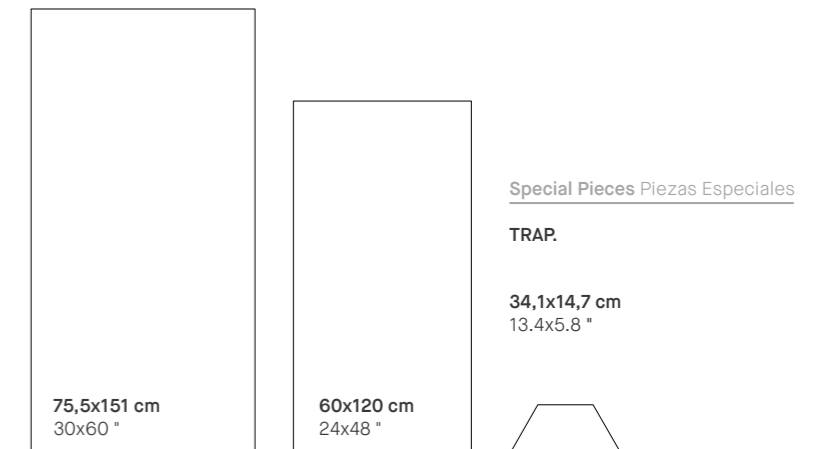

FORMATS



- 01.  OPERA FUMO/60X20/EP
- 02.  OPERA FUMO/75,5X151/EP
- 03. OPERA FUMO/75,5X151/EP in a private residence. Architect: Lasut&Braun. Photography: Zahra Azzouz, Qoeqa fotografie.
- 04. OPERA FUMO close-up

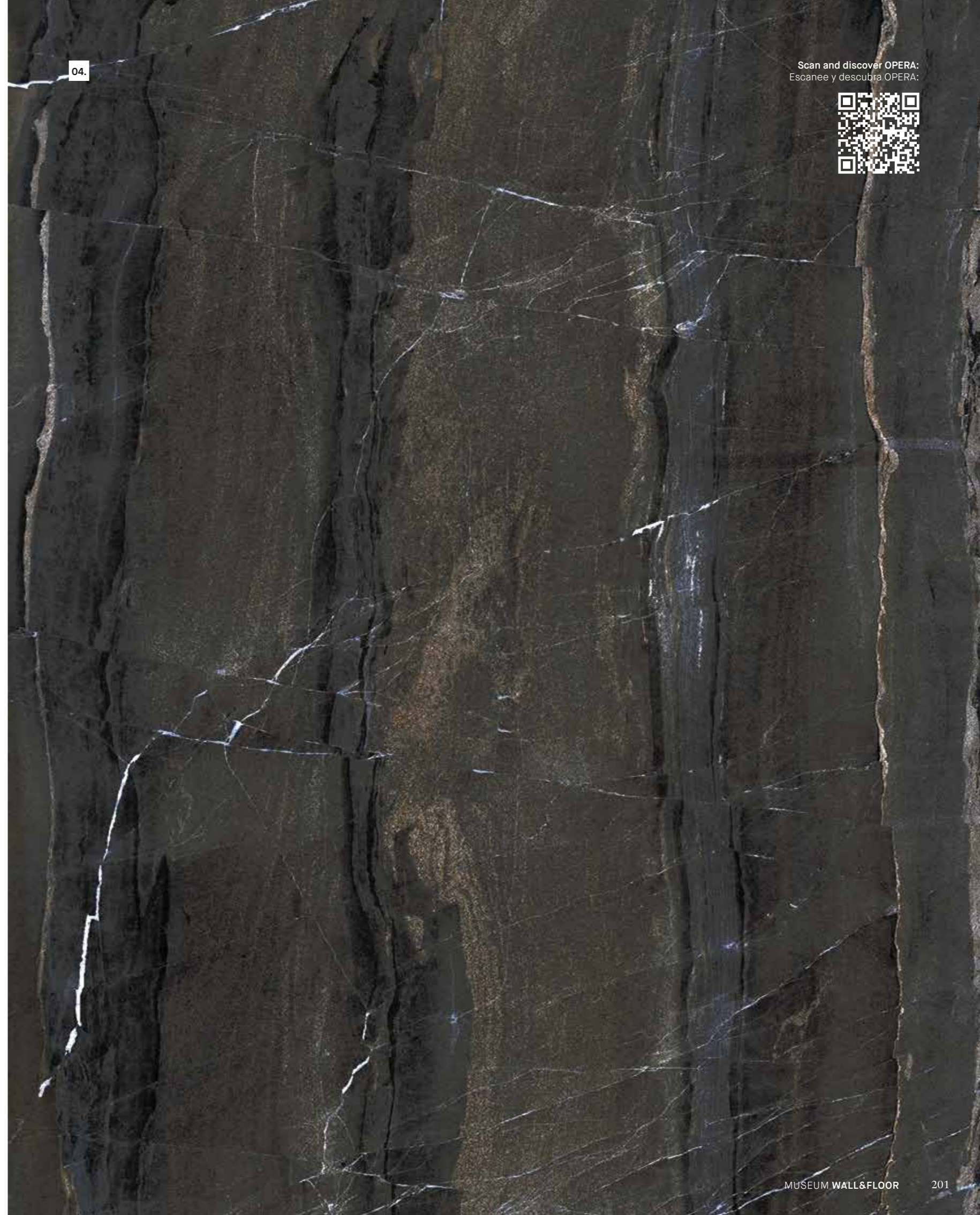

Scan and discover OPERA:
Escanee y descubra OPERA:







PATTERNS VARIETY VARIEDAD GRÁFICA OPERA FUMO 60x120 cm FORMAT OPERA FUMO FORMATO 60x120 cm

FORMATS FORMATOS

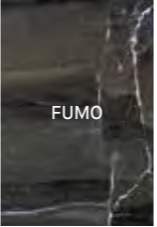
		Porcelain Porcelánico	
		75,5x151 cm 30x60"	60x120 cm 24x48"
Thickness Espesor		10 mm	
Patterns Gráficas		12	20
	Polished (EP)	25971 M74	25964 M73

SPECIAL PIECES PIEZAS ESPECIALES

Porcelain Porcelánico (10 mm)			
TRAP.	34,1x14,7 cm 13.4x5.8"		
	FUMO	Polished (EP)	26319 U28

COMPLEMENTARY PIECES PIEZAS COMPLEMENTARIAS

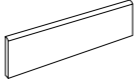
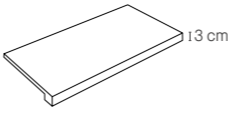
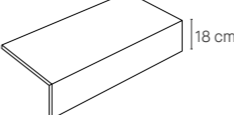
S.K.I. S.K.D.		SKIRTING		
	8x30 cm 3.1x11.8"		8x75,5 cm 3.1x29.7"	8x60 cm 3.1x23.6"
Polished (EP)	U53	Polished (EP)	U43	U35
STAIR TREADS				
TECHNICAL (PT)		SEAMLESS (PL/18)		
	13 cm		18 cm	
		30x151 cm 11.8x59.4"	30x120 cm 11.8x47.2"	30x75,5 cm 11.8x29.7"
			30x60 cm 11.8x23.6"	
Polished (EP)		U86	U75	U76
			U54	

OROBICO

Arabescato OROBICO is a lovely marble with an untameable unique design. Its dark grey background is decorated in beige and caramel filaments, creating a stylish, highly singular colour combination. Orobico's strong sense of movement in all four directions brings a chic dynamism to living spaces of all kinds.

The collection comes in two versions, Dark and Light, both inter-combinable. It is only available in a Polished finish in a 75.5x151 cm or 60x120 cm format. OROBICO also features a *book match* version in a 75.5x151 cm format as a decorative option.

El mármol precioso *Arabescato* OROBICO destaca tanto por la belleza particular de su gráfica salvaje, como la intensidad de su fondo gris oscuro, que unido a variaciones de filamentos beige y color caramelo, le confieren una gama cromática única y elegante. Su riqueza de movimiento en los cuatro sentidos aporta dinamismo y sofisticación para todo tipo de espacios.

Representado en dos versiones Dark y Light totalmente combinables entre sí. Está disponible en un único acabado Pulido, y en formatos 75,5x151 cm y 60x120 cm. Además, como elemento decorativo, dispone del *book match* en 75,5x151 cm.

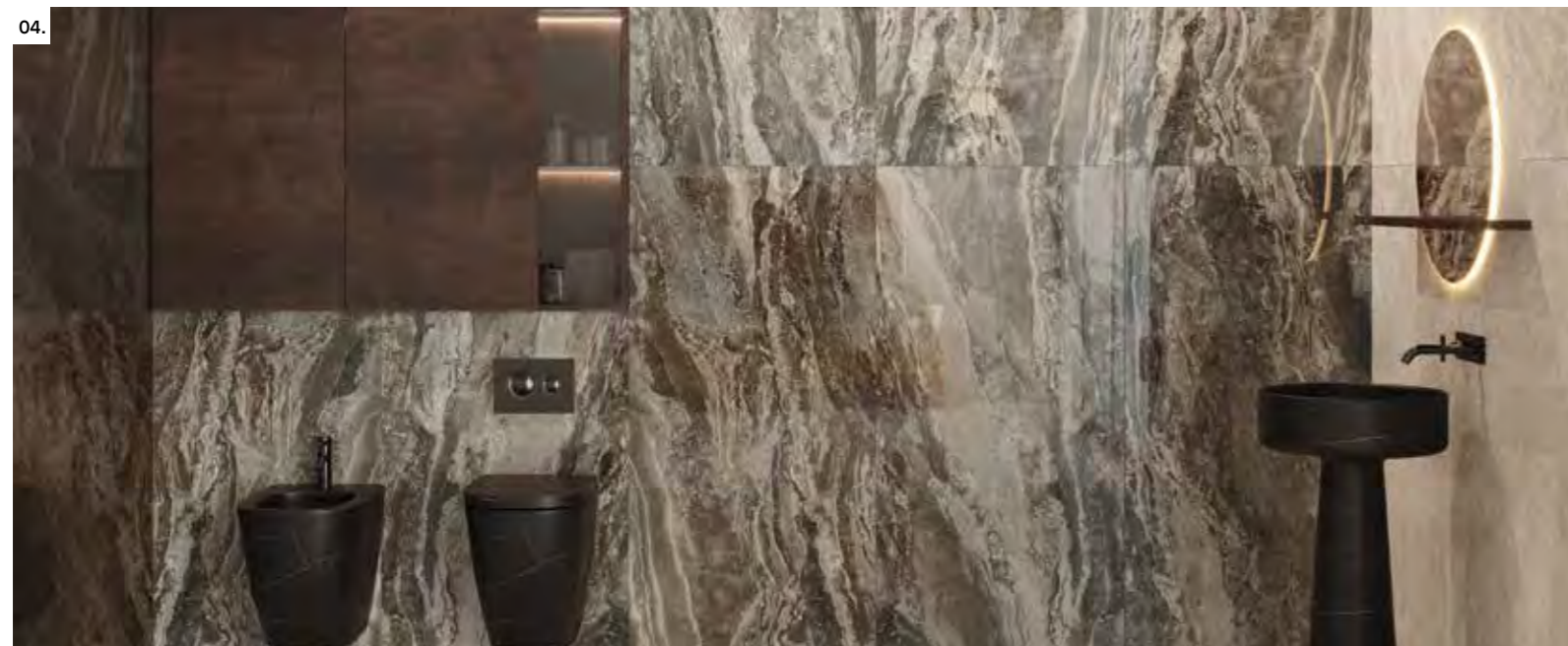

COLOURS

LIGHT



DARK



FINISH



FORMATS

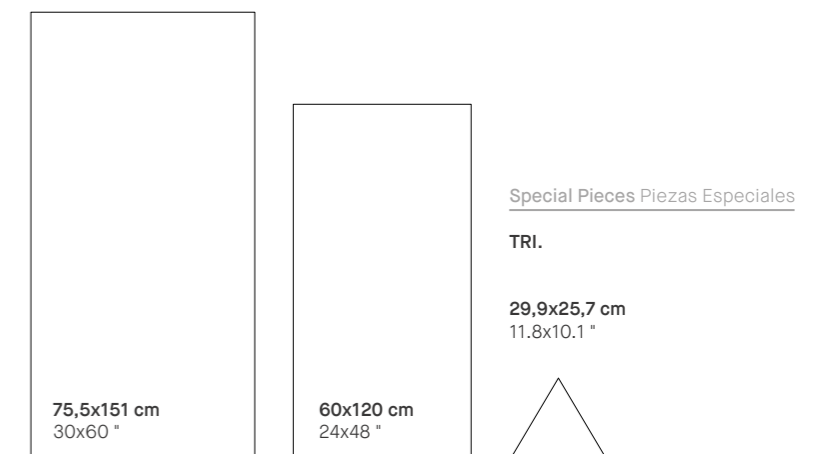

- 01. ■ OROBICO LIGHT/75,5X151/EP
- 02. ■ BM OROBICO A/75,5X151/EP & BM OROBICO B/75,5X151/EP
- 03. ■ OROBICO DARK/75,5X151/EP
- 04. OROBICO LIGHT close-up.



Scan and discover OROBICO:
Escanee y descubra OROBICO:







PATTERNS VARIETY VARIEDAD GRÁFICA OROBICO LIGHT 75,5x151 cm FORMAT OROBICO LIGHT FORMATO 75,5x151 cm

FORMATS FORMATOS

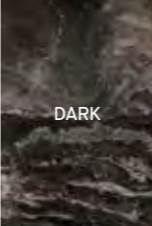
		Porcelain Porcelánico	
		75,5x151 cm 30x60"	60x120 cm 24x48"
Thickness Espesor		10 mm	
Patterns Gráficas		14	14
	LIGHT Polished (EP)	27337 M74	27336 M73
	DARK Polished (EP)	27338 M74	27335 M73

Book Match option 1

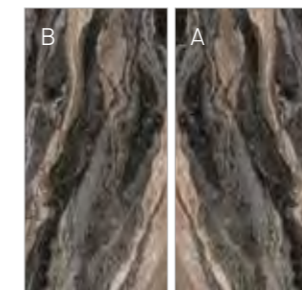

Book Match option 2

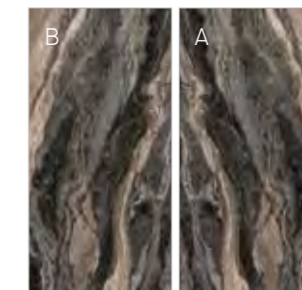

		Porcelain Porcelánico	
BOOK MATCH 75,5x151 cm 30x60"			
	Polished (EP)	A	27339 M86
		B	27340 M86

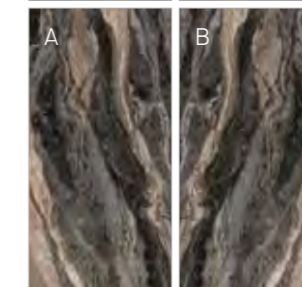
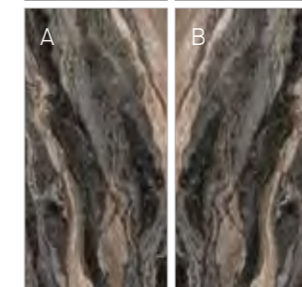

SPECIAL PIECES PIEZAS ESPECIALES

Porcelain Porcelánico (10 mm)

TRI.	29,9x25,7 cm 11.8x10.1 "		
	LIGHT	Polished (EP)	27845 U34
	DARK	Polished (EP)	27846 U34

COMPLEMENTARY PIECES PIEZAS COMPLEMENTARIAS

S.K.I. S.K.D.



8x30 cm
3.1x11.8 "

Polished (EP) U53

SKIRTING

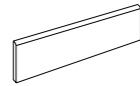

8x75,5 cm 8x60 cm
3.1x29.7 " 3.1x23.6 "

Polished (EP) U43 U35

STAIR TREADS

TECHNICAL (PT)

SEAMLESS (PL/18)

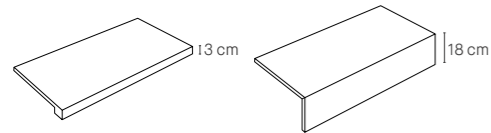

13 cm 18 cm
30x151 cm 30x120 cm 30x75,5 cm 30x60 cm
11.8x59.4 " 11.8x47.2 " 11.8x29.7 " 11.8x23.6 "

Polished (EP) U86 U75 U76 U54

09. ■ D. OROBICO LIGHT OAT DIAGONALE/30X30/EP



PRALINÉ

PRALINÉ is inspired by exclusive italian *Calacatta Macchia Vecchia* marble. Its white marble design, streaked with grey veins, stands out for the hint of caramel in the veining, lending it personality and distinction. Thanks to PRALINÉ's warmth and luminosity, it is a perfect choice for interior design and architectural projects.

Available in a 100x275 cm, 100x180 cm, 100x100 cm, 75,5x151 cm or 60x120 cm format, the collection comes in a choice of a Premium Polished, Polished, Shaped or Natural finish. It also features 33,3x100 cm white-body wall tiles, with a matching DEEP TECH décor, and a 75,5x151 cm *book match* décor in a Polished finish.

PRALINÉ se inspira en el exclusivo mármol *Calacatta Macchia Vecchia* de origen italiano. Su diseño de mármol blanco con vetas grises destaca por un veteado en tonalidad caramelo, el cual le confiere identidad y distinción. En proyectos de interiorismo y arquitectura se convierte en la alternativa perfecta gracias a su calidez y luminosidad.

Se presenta en los formatos 100x275 cm, 100x180 cm, 100x100 cm, 75,5x151 cm y 60x120 cm, y en los acabados Premium Polished, Polished, Shaped y Natural. Incorpora un revestimiento de pasta blanca en 33,3x100 cm con su correspondiente decorado en DEEP TECH. Y además, incluye la opción decorativa en *book match* en formato 75,5x151 cm y acabado Polished.



COLOURS

GOLD



FINISHES

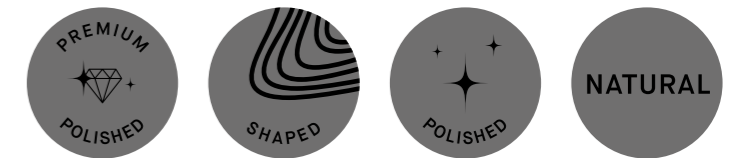

FORMATS

150x320 cm available (ELEVATE WORKTOPS).
Disponibile 150x320 cm (ELEVATE WORKTOPS).

Special Pieces Piezas Especiales

D. MIX	D. TRIANGLE	D. ARR
30x30 cm 11.8x11.8"	29x29 cm 11.4x11.4"	9,6x44,9 cm 5.9x13.6"

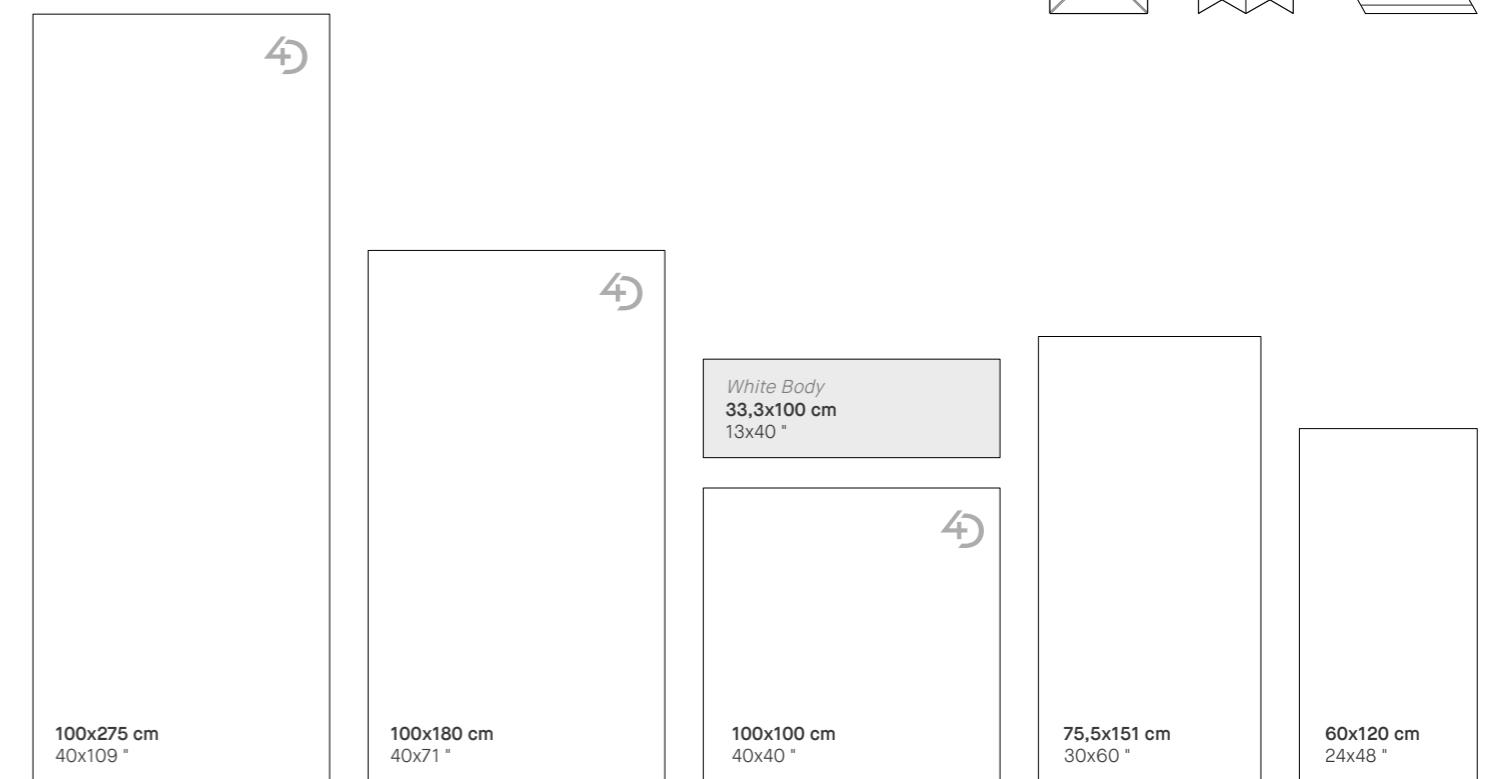

- 01. ■ PRALINÉ GOLD NT/75,5X151/R
- 02. PRALINÉ GOLD SP
- 03. ■ PRALINÉ GOLD DECOR SP/33X100/R
- 04. MUSEUM experience showroom
- 05. PRALINÉ GOLD close-up

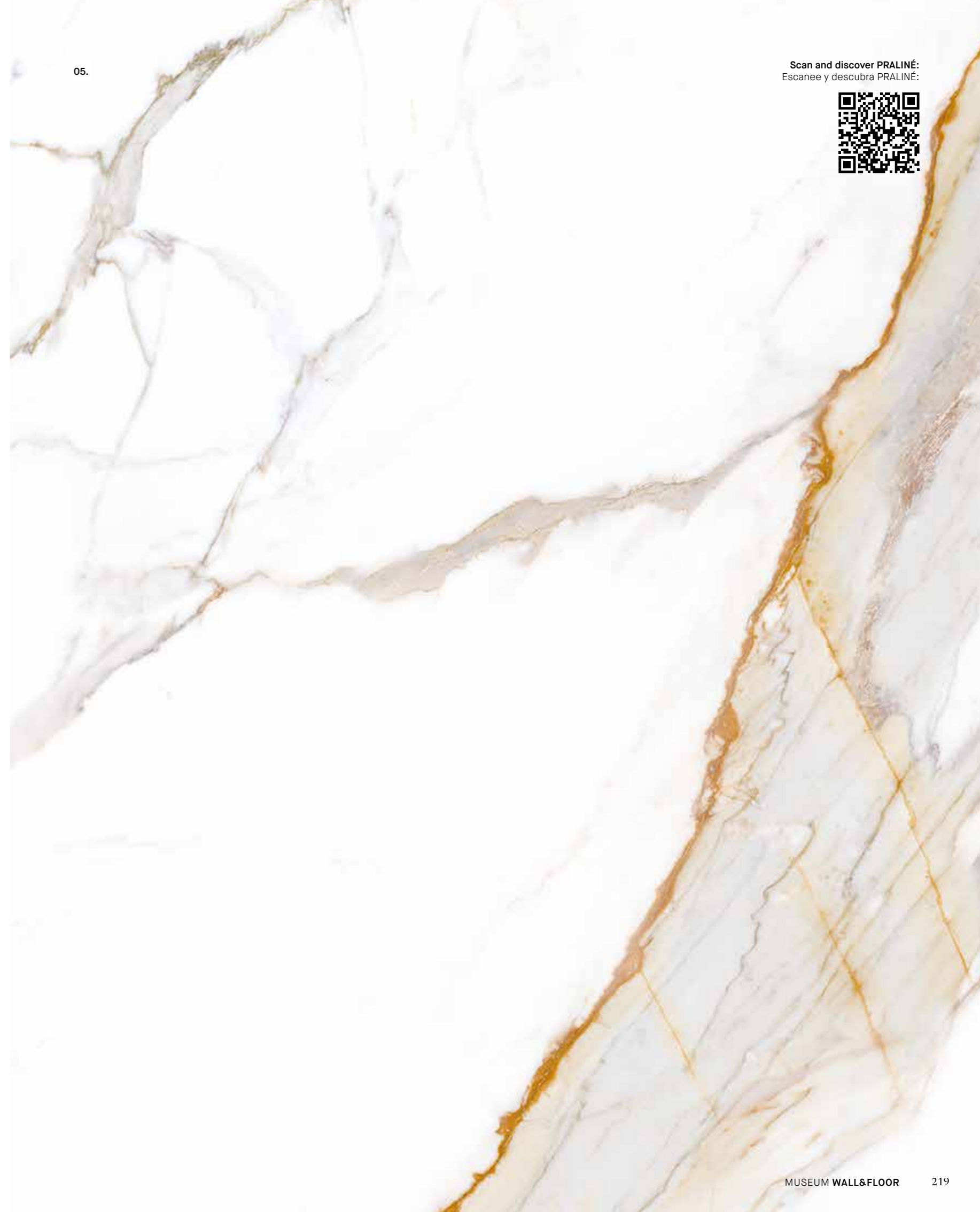

Scan and discover PRALINÉ:
Escanee y descubra PRALINÉ:



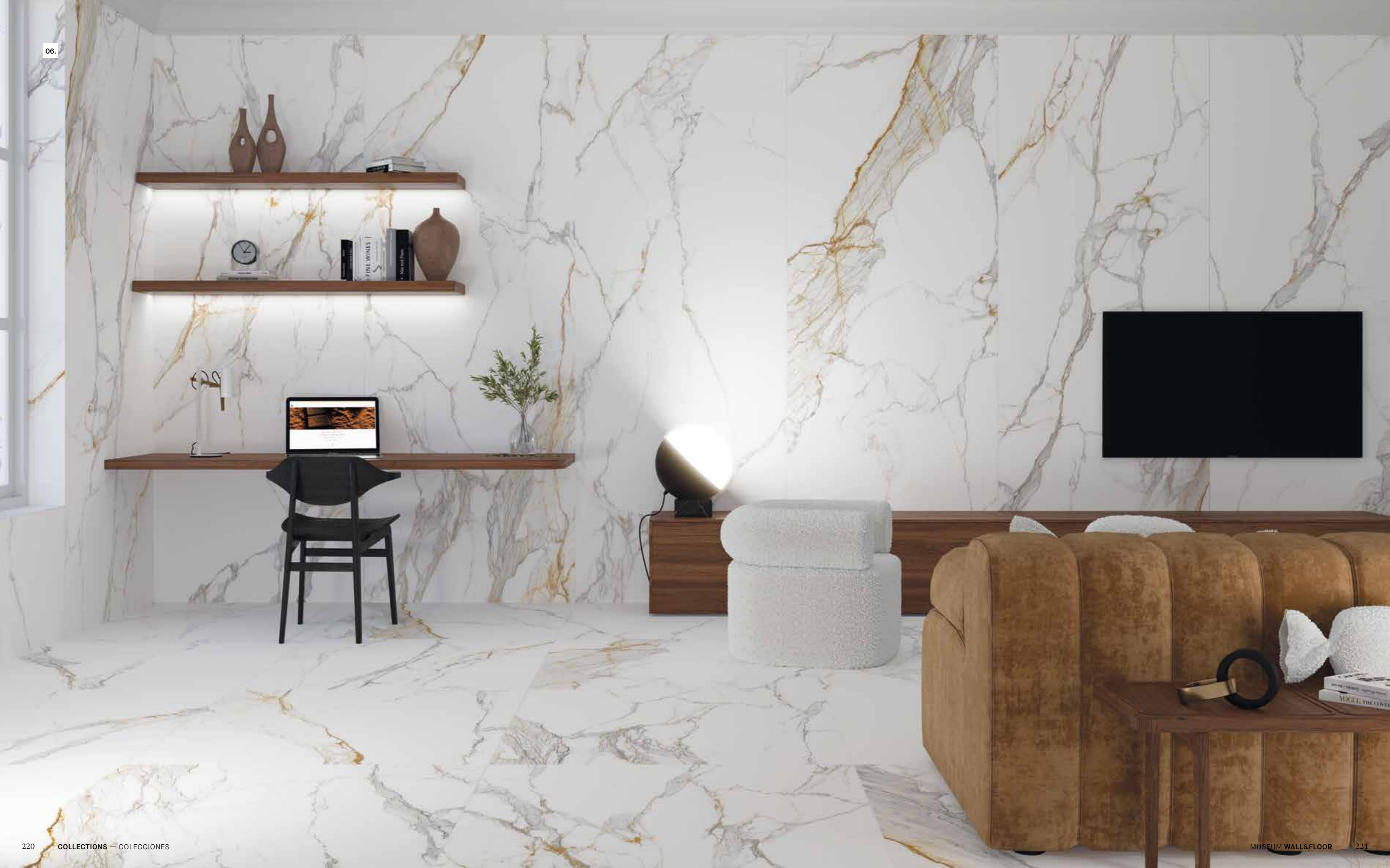

07.



- 06. ■ PRALINE GOLD SP/100X275/R ■ PRALINE GOLD SP/100X100/R
- 07. ■ PRALINE GOLD DECOR SP/33X100/R ■ GROW HONEY SP/24X151/R
- 08. ■ PRALINE GOLD DECOR SP/33X100/R

08.





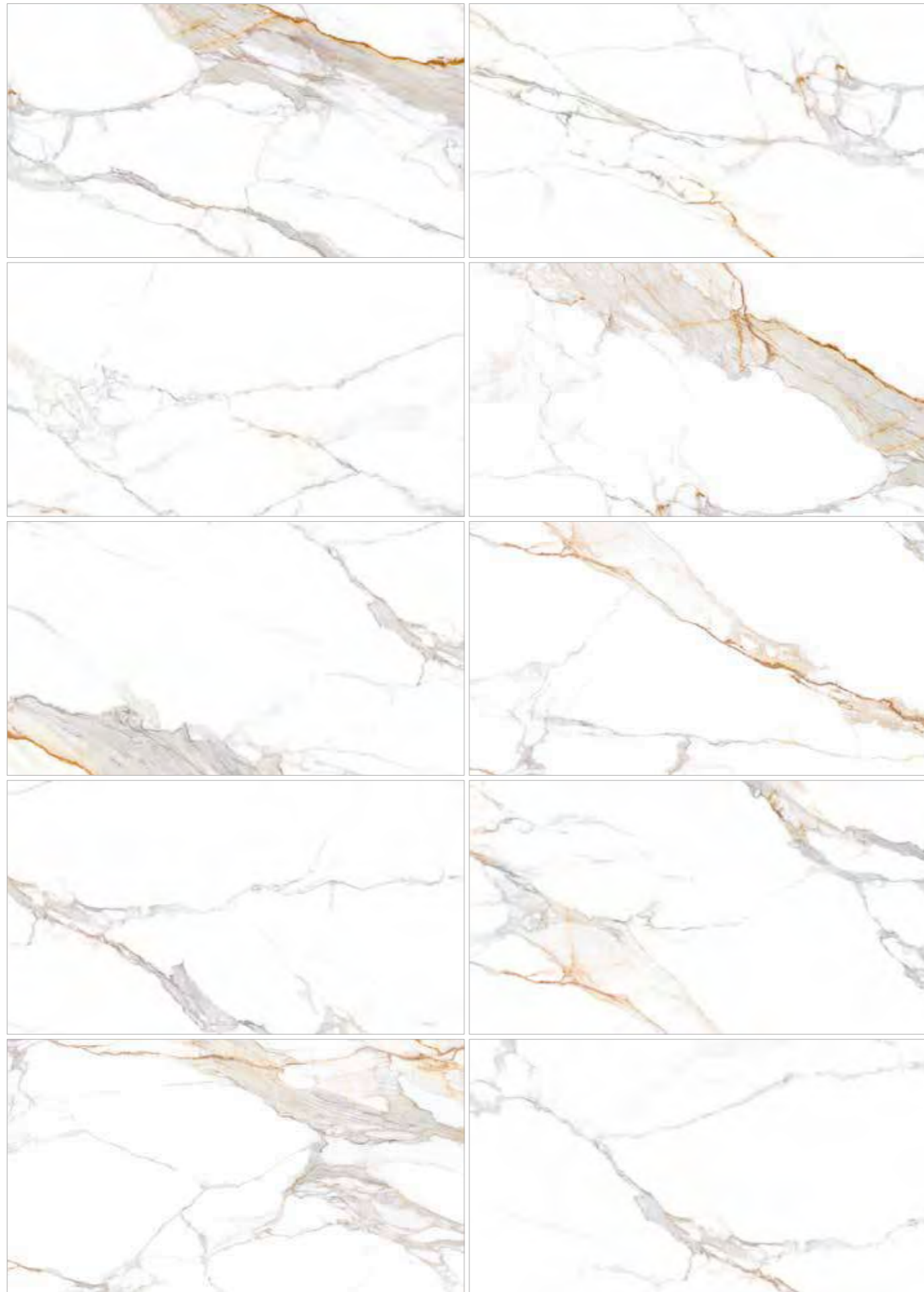

PATTERNS VARIETY VARIEDAD GRÁFICA PRALINÉ GOLD 100x180 cm FORMAT PRALINÉ GOLD FORMATO 100x180 cm

FORMATS FORMATOS

		Porcelain Porcelánico				White Body Pasta Blanca		
		100x275 cm 40x109"	100x180 cm 40x71"	100x100 cm 40x40"	75,5x151 cm 30x60"	60x120 cm 24x48"	33,3x100 cm 13x40"	33,3x100 cm 13x40" DECOR
Thickness Espesor	Patterns Gráficas	6 mm	8 mm		10 mm		10,5 mm	13,5 mm
		6	12	15	15	20	23	23
GOLD	Premium Polished (P)	-	34675 M76	-	-	-	-	-
	Shaped (SP)	34681 M100	34674 M94	34673 M93	-	-	34676 M96	34677 M97
	Polished (EP)	-	-	-	34672 M58	34670 M40	-	-
	Natural (NT)	-	-	-	34671 M103	34669 M101	-	-

Book Match option 1

Book Match option 2

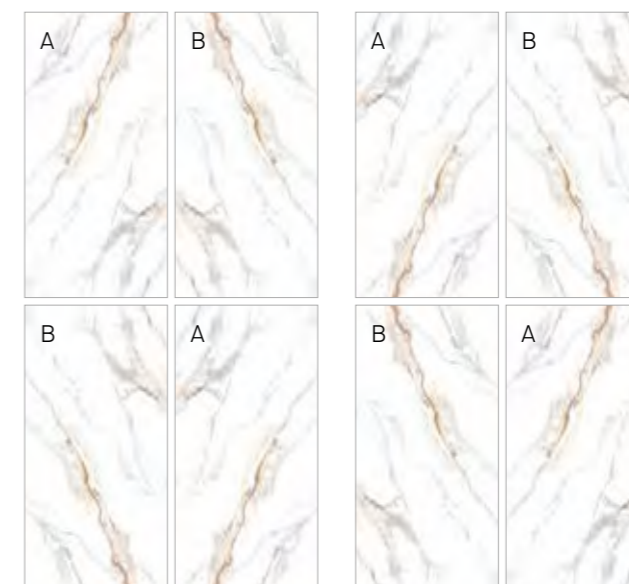

Porcelain Porcelánico

BOOK MATCH 75,5x151 cm 30x60"

GOLD	Polished (EP)	A	34708 M74
		B	34709 M74

SPECIAL PIECES PIEZAS ESPECIALES

Porcelain Porcelánico (10 mm)

** D. ARR. 1 14,6x51 cm 5.7x20.1 "			
	PRALINÉ GOLD GROW HONEY	Natural (NT) Shaped (SP)	34894 U51
	PRALINÉ GOLD GROW HONEY	Polished (EP) Shaped (SP)	34892 U51
** D. ARR. 2			
	PRALINÉ GOLD GROW HONEY	Natural (NT) Shaped (SP)	34895 U51
	PRALINÉ GOLD GROW HONEY	Polished (EP) Shaped (SP)	34893 U51

Porcelain Porcelánico (10 mm)

D. MIX 30x30 cm 11.8x11.8 "			
	PRALINÉ GOLD PRALINÉ GOLD GROW KALUA	Natural (NT) Polished (EP) Shaped (SP)	34889 U51
White Body Pasta Blanca (10,5 mm)			
* D. TRIANGLE 29x29 cm 11.4x11.4 "			
	GOLD	Shaped (SP)	34890 U53

** Only suitable for wall installations.
** Adecuado únicamente como revestimiento.

* Random colour position.
* Posición de colores aleatoria.

** 1 m² composition = 14 pieces
(7 pieces D.ARR 1 + 7 pieces D.ARR 2)
aproximately.

** Composición 1 m² = 14 piezas
(7 piezas D.ARR 1 + 7 piezas D.ARR 2)
aproximadamente.

COMPLEMENTARY PIECES PIEZAS COMPLEMENTARIAS

S.K.I. S.K.D.



8x30 cm
3.1x11.8 "

SKIRTING



8x100 cm 8x75,5 cm 8x60 cm
3.1x39.4 " 3.1x29.7 " 3.1x23.6 "

Finish	U53	U48	-	-
Premium Polished (P)	U53	U48	-	-
Shaped (SP)	U53	U45	-	-
Polished (EP)	U53	-	U43	U35
Natural (NT)	U53	-	U43	U35

STAIR TREADS

TECHNICAL (PT) SEAMLESS (PL/18)

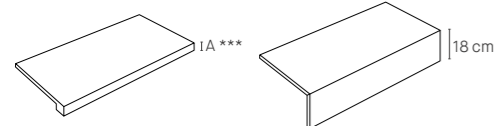

30x180 cm 30x151 cm 30x120 cm 30x100 cm 30x75,5 cm 30x60 cm
11.8x70.8 " 11.8x59.4 " 11.8x47.2 " 11.8x39.4 " 11.8x29.7 " 11.8x23.6 "

Finish	U90	-	-	U74	-	-
Premium Polished (P)	U90	-	-	U74	-	-
Shaped (SP)	U90	-	-	U74	-	-
Polished (EP)	-	U86	U75	-	U76	U54
Natural (NT)	-	U86	U75	-	U76	U54

*** When thickness is
6 mm, A = 18 mm;
when 8 mm, then A = 24 mm;
when 10 mm, then A = 30 mm.
*** Cuando el espesor es
6 mm, A = 18 mm;
cuando es 8 mm, A = 24 mm;
cuando es 10 mm, A = 30 mm.

TECHNICAL DATA DATOS TÉCNICOS

	DIN 51130	DIN 51097	UNE-41901 EX	BS 7976-2 (PTV)	ANSI A137.1 (DCOF)
Shaped (SP) 6-8 mm	-	-	Class 1	-	>0,42
Natural (NT)	R10	A + B	Class 2	+36 Wet	>0,42

10. ■ D. PRALINE GOLD/HONEY ARR.1/14,6X51/SP & D. PRALINE GOLD/HONEY ARR.2/14,6X51/SP



PREMIERE

PREMIERE is an absolute must for design lovers. Inspired by the stone known as *Invisible Marble*, the collection's select design stands out for its anthracite-coloured veins with touches of blue. Combining its dazzling white background and warm beige shades, Premiere's delicate beauty draws all eyes.

The collection comes in a 100x275 cm, 100x180 cm or 100x100 cm 4D TECH formats in a choice of a Premium Polished or Shaped finish and a 75.5x151 cm or 60x120 cm format in a Polished or Shaped finish.

PREMIERE surge como una de las colecciones más deseadas para los amantes del diseño. Proviene de la familia de los *mármoles invisibles*, y su exclusiva gráfica destaca por un veteado antracita con motivos azulados. Representa un conjunto de lo más delicado gracias a la pureza de su fondo blanco y a la calidez de los tonos beige.

Disponible en formatos 4D TECH 100x275 cm, 100x180 cm y 100x100 cm en acabados Premium Polished y Shaped, también ofrece los formatos 75,5x151 cm y 60x120 cm en acabados Polished y Shaped.



COLOURS

WHITE



FINISHES







FORMATS

Special Pieces Piezas Especiales

D. MIX	D. CHEVRON
30x30 cm 11.8x11.8"	30x21,9 cm 11.8x8.6"



- 01.  PREMIERE WHITE SP/75,5X151/R
- 02.  PREMIERE WHITE SP/100X275/R
- 03.  PREMIERE WHITE SP/100X180/R  INFINITY BLACK NT/150X320/R
- 04. PREMIERE WHITE SP
- 05. PREMIERE WHITE close-up



Scan and discover PREMIERE:
Escanee y descubra PREMIERE:









PATTERNS VARIETY VARIEDAD GRÁFICA PREMIERE WHITE 100X180 cm FORMAT PREMIERE WHITE 100X180 cm

FORMATS FORMATOS

		Porcelain Porcelánico					
		100x275 cm 40x109 "	100x180 cm 40x71 "	100x100 cm 40x40 "	75,5x151 cm 30x60 "	60x120 cm 24x48 "	
Thickness Espesor		6 mm		8 mm		10 mm	
Patterns Gráficas		8		12		16	
WHITE	Shaped (SP)	36118 M100	32932 M94	32931 M93	32930 M103	32929 M101	
	Premium Polished (P)	-	32933 M76	-	-	-	
	Polished (EP)	-	-	-	32934 M58	32908 M40	

SPECIAL PIECES PIEZAS ESPECIALES

Porcelain Porcelánico (10 mm)

D.CHEVRON 30x21,9 cm 11.8x8.6 "			
	PREMIERE WHITE GROW HONEY	Polished (EP) Shaped (SP)	33209 U55
	PREMIERE WHITE GROW HONEY	Shaped (SP)	33208 U55

Porcelain Porcelánico (10 mm)

* D. MIX 30x30 cm 11.8x11.8 "			
	PREMIERE WHITE GROW HAZEL PREMIERE WHITE	Shaped (SP) Shaped (SP) Polished (EP)	33217 U55

* Random colour position.
* Posición de colores aleatoria.

COMPLEMENTARY PIECES PIEZAS COMPLEMENTARIAS

S.K.I. S.K.D.



8x30 cm
3.1x11.8 "

SKIRTING



8x100 cm 3.1x39.4 "
8x75,5 cm 3.1x29.7 "
8x60 cm 3.1x23.6 "

	8x30 cm 3.1x11.8 "	8x100 cm 3.1x39.4 "	8x75,5 cm 3.1x29.7 "	8x60 cm 3.1x23.6 "
Shaped (SP)	U53	U45	U43	U35
Premium Polished (P)	U53	U48	-	-
Polished (EP)	U53	-	U43	U35

STAIR TREADS

TECHNICAL (PT)

SEAMLESS (PL/18)

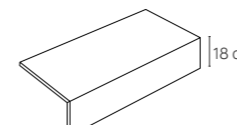
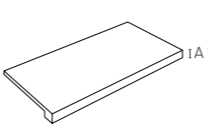

30x180 cm 11.8x70.8 "
30x151 cm 11.8x59.4 "
30x120 cm 11.8x47.2 "
30x100 cm 11.8x39.4 "
30x75,5 cm 11.8x29.7 "
30x60 cm 11.8x23.6 "

	30x180 cm 11.8x70.8 "	30x151 cm 11.8x59.4 "	30x120 cm 11.8x47.2 "	30x100 cm 11.8x39.4 "	30x75,5 cm 11.8x29.7 "	30x60 cm 11.8x23.6 "
Shaped (SP)	U90	U86	U75	U74	U76	U54
Premium Polished (P)	U90	-	-	U74	-	-
Polished (EP)	-	U86	U75	-	U76	U54

** When thickness is
6 mm, A = 18 mm;
when 8 mm, then A = 24 mm;
when 10 mm, then A = 30 mm.
** Cuando el espesor es
6 mm, A = 18 mm;
cuando es 8 mm, A = 24 mm;
cuando es 10 mm, A = 30 mm.

TECHNICAL DATA DATOS TÉCNICOS

	DIN 51130	DIN 51097	UNE-41901 EX	BS 7976-2 (PTV)	ANSI A137.1 (DCOF)
Shaped (SP) 6-8 mm		-	Class 1	-	>0,42
Shaped (SP) 10 mm	R10	A + B	Class 2	+36 Wet	>0,42

STATUARIO PLUS

This exclusive porcelain tile collection emulates some of the finest, more unusual examples of *Carrara marble*, taking nature as its source of inspiration to create tiles whose longitudinal black veins lend surfaces a unique timeless elegance.

Available in a 60x120 cm or 75,5x151 cm format in a Polished finish, STATUARIO PLUS brings a chic sophistication to living spaces of all kinds.

Esta especial interpretación del mármol procedente de *Carrara* se concentra en los cortes más puros y poco frecuentes del mismo. La colección STATUARIO PLUS se sirve de la inspiración natural para crear un porcelánico exclusivo en el mercado que gracias a su venatura negra longitudinal le confieren una elegancia única, convirtiéndolo en un producto atemporal.

Disponible en formato 60x120 cm y 75,5x151 cm en acabado Pulido, la sofisticación de esta colección se transfiere a todo tipo de espacios.



COLOURS

WHITE



FINISHES

FORMATS

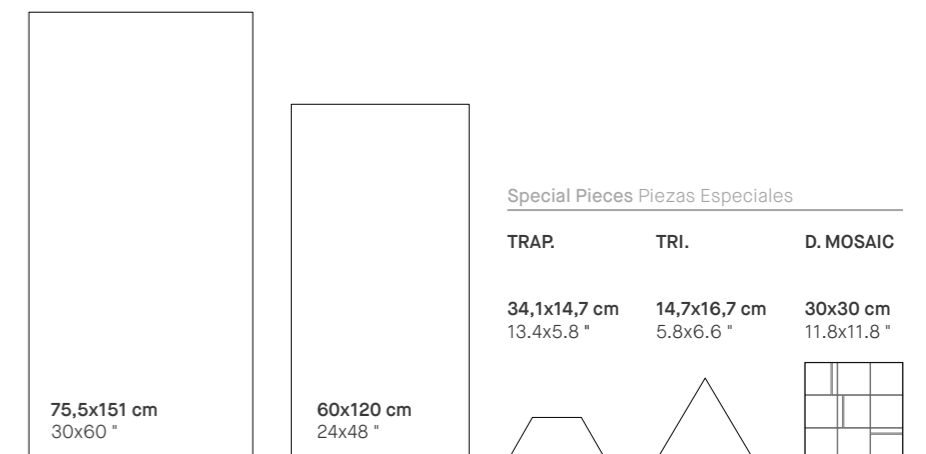

- 01. ■ STATUARIO PLUS/75,5X151/EP
- 02. 03. Interior design project by ATG Design using STATUARIO PLUS/75,5X151/EP.
- 04. STATUARIO PLUS/90X90/EP
- 05. STATUARIO PLUS close-up

Scan and discover STATUARIO PLUS:
Escanee y descubra STATUARIO PLUS:

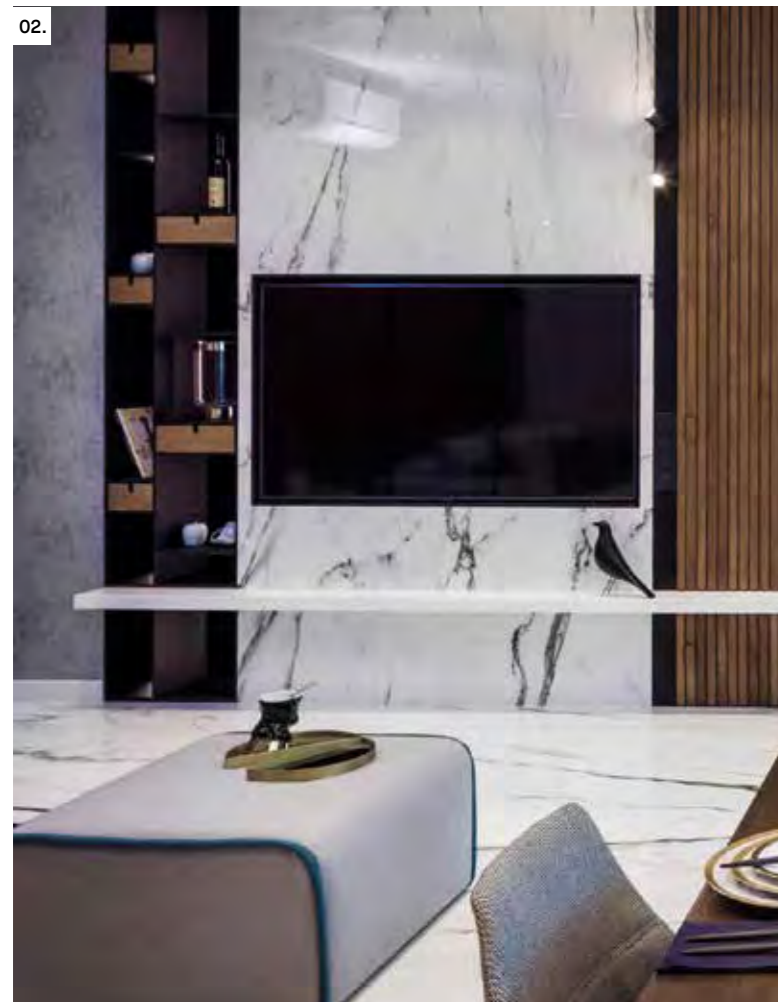
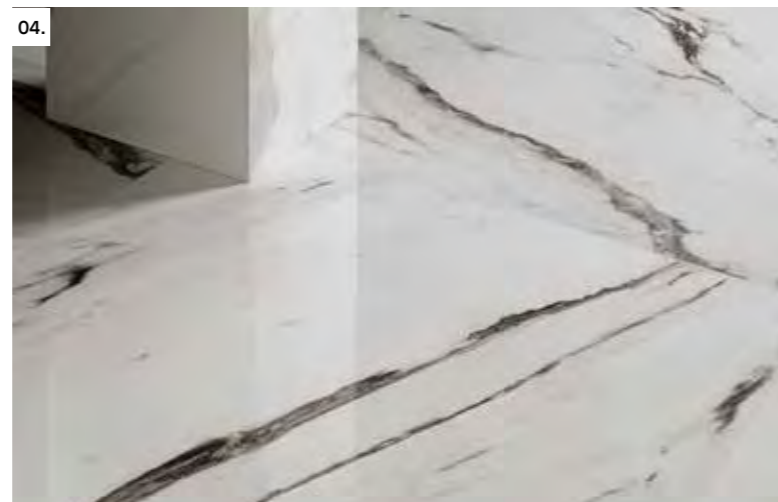







PATTERNS VARIETY VARIEDAD GRÁFICA STATUARIO PLUS WHITE 60x120 cm FORMAT STATUARIO PLUS WHITE FORMATO 60x120 cm

FORMATS FORMATOS

		Porcelain Porcelánico	
		75,5x151 cm 30x60 "	60x120 cm 24x48 "
Thickness Espesor		10 mm	
Patterns Gráficas		15	16
 WHITE	Polished (EP)	23463 M58	23462 M40

SPECIAL PIECES PIEZAS ESPECIALES

Porcelain Porcelánico (10 mm)				Porcelain Porcelánico (10 mm)			
TRAP.	34,1x14,7 cm 13.4x5.8 "			TRI.	14,7x16,7 cm 5.8x6.6 "		
	WHITE	Polished (EP)	23564 U28		WHITE	Polished (EP)	23561 U13
Porcelain Porcelánico (10 mm)							
D. MOSAIC	30x30 cm 11.8x11.8 "						
	WHITE	Polished (EP)	23541 U58				

* Only suitable for wall installations.
* Adecuado únicamente como revestimiento.

COMPLEMENTARY PIECES PIEZAS COMPLEMENTARIAS

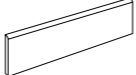
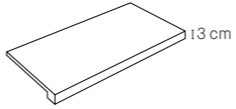
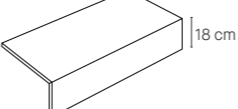
S.K.I. S.K.D.		SKIRTING			
	8x30 cm 3.1x11.8 "		8x75,5 cm 3.1x29.7 "	8x60 cm 3.1x23.6 "	
Polished (EP)	U53	Polished (EP)	U43	U35	
STAIR TREADS					
TECHNICAL (PT)		SEAMLESS (PL/18)			
	13 cm		18 cm	30x151 cm 11.8x59.4 "	30x120 cm 11.8x47.2 "
				30x75,5 cm 11.8x29.7 "	30x60 cm 11.8x23.6 "
		Polished (EP)		U86	U75
				U76	U54

STRÖND

STRÖND is inspired by the world's more secluded beaches. The tiles feature a mix of stone designs, with finer details in shades of varying intensities on each one. The collection's Shaped finish further enhances its realism and natural appeal.

The collection comes in a choice of 3 colours –Cloud, Oat and Dolphin– in a 100x275 cm, 100x180 cm, 100x100 cm, 50x100 cm, 60x120 cm or 90x90 cm format. Thanks to the use of 4D technology the collection also includes an extra-thick 20 mm model in a 100x100 cm and 50x100 cm formats for use outdoors.

La colección STRÖND se inspira en las playas más recónditas del mundo. Representa un mix de gráficas pétreas con detalles de variedad tonal dentro de cada pieza, logrando mayor realismo gracias al acabado Shaped.

Disponibile in tres colores diferentes: Cloud, Oat y Dolphin. En formatos 100x275 cm, 100x180 cm, 100x100 cm, 50x100 cm, 60x120 cm y 90x90 cm. Además, gracias a la tecnología 4D, se ofrece como solución de exterior el formato 100x100 cm y el 50x100 cm en espesor 20 mm.



COLOURS

CLOUD



OAT



DOLPHIN



FINISHES



FORMATS

Special Pieces Piezas Especiales

D. MOSAIC

D. MIX

30x30 cm
11.8x11.8 *

30x30 cm
11.8x11.8 *

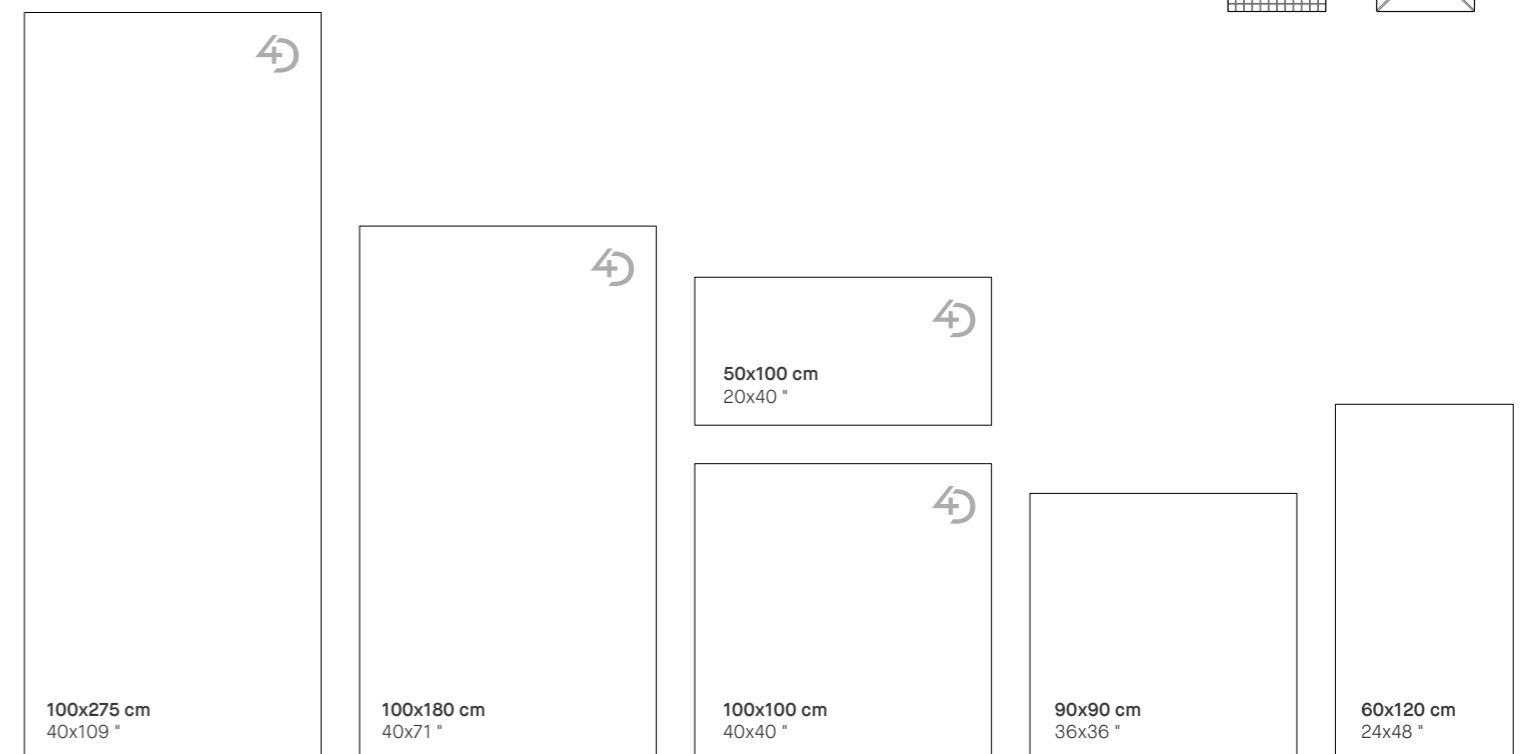
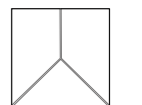
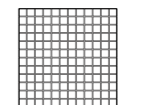

- 01. ■ STROND CLOUD SP/100X275/R
- 02. ■ STROND CLOUD 100X100X2/A/R
- 03. STROND CLOUD SP
- 04. ■ STROND DOLPHIN 100X100X2/A/R
- 05. STROND OAT close-up



05.

Scan and discover the STRÖND:
Escanee y descubra STRÖND:

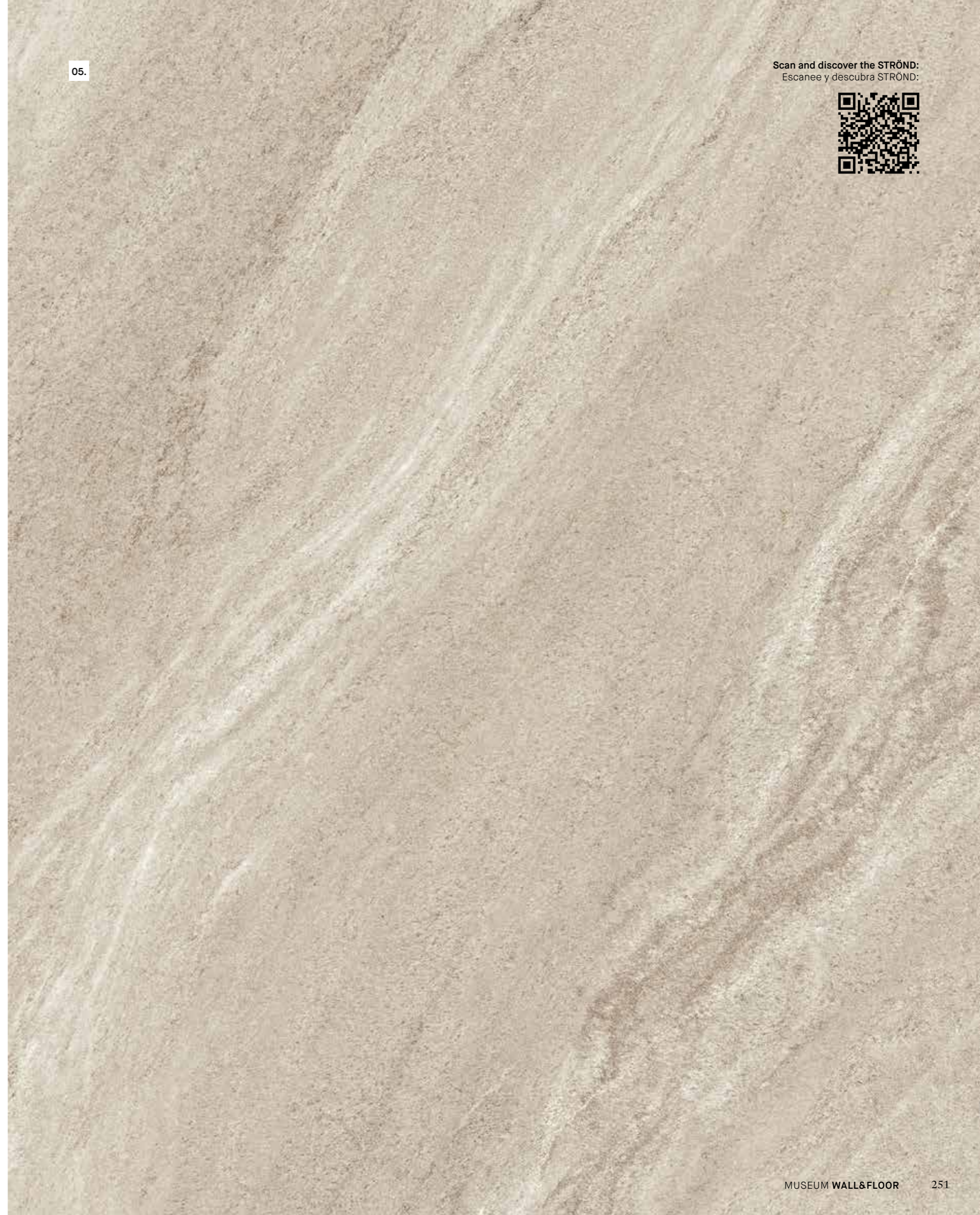



07.



- 06. ■ STROND DOLPHIN SP/100X275/R ■ STROND DOLPHIN/100X100X2/A/R
- 07. ■ STROND OAT 100X100X2/A/R
- 08. ■ STROND OAT 100X100X2/A/R

08.





10.



- 09. ■ STROND CLOUD SP/90X90/R & STROND CLOUD /90X90/A/R
- 10. ■ STROND OAT SP/100X180/R & GROW TAUPE SP/33X100/R ■ STROND OAT SP/100X100/R
- 11. STROND OAT SP

11.





PATTERNS VARIETY VARIEDAD GRÁFICA STRÖND DOLPHIN 100X180 cm FORMAT STRÖND DOLPHIN 100X180 cm

FORMATS FORMATOS

Porcelain Porcelánico

		100x275 cm 40x109 "	100x180 cm 40x71 "	100x100 cm 40x40 "	50x100 cm 20x40 "	60x120 cm 24x48 "	90x90 cm 36x36 "
Thickness Espesor		6 mm		8 mm / 20 mm		20 mm	
Patterns Gráficas		5		9		15	
CLOUD	Shaped (SP)	36125 M90	32861 M94	31761 M93	-	32852 M101	32855 M102
	Antislip (A)	-	-	32864 M113	35571 M115	-	32858 M81
OAT	Shaped (SP)	36126 M90	32863 M94	31763 M93	-	32854 M101	32856 M102
	Antislip (A)	-	-	32866 M113	35573 M115	-	32860 M81
DOLPHIN	Shaped (SP)	36878 M90	32862 M94	31764 M93	-	32853 M101	32857 M102
	Antislip (A)	-	-	32865 M113	35572 M115	-	32859 M81

TECHNICAL DATA DATOS TÉCNICOS

	DIN 51130	DIN 51097	UNE-41901 EX	BS 7976-2 (PTV)	ANSI A137.1 (DCOF)
Shaped (SP) 6-8 mm	-	-	Class 1	-	>0,42
Shaped (SP) 10 mm	R10	A + B	Class 2	+36 Wet	>0,42
Antislip (A)	R11	A + B + C	Class 3	+36 Wet	>0,42

SPECIAL PIECES PIEZAS ESPECIALES

Porcelain Porcelánico (10 mm)

D. MOSAIC 30x30 cm 11.8x11.8 "			
	STRÖND CLOUD	Shaped (SP)	33090 U36
	STRÖND OAT	Shaped (SP)	33092 U36
	STRÖND DOLPHIN	Shaped (SP)	33091 U36

Porcelain Porcelánico (10 mm)

D. MIX 30x30 cm 11.8x11.8 "			
	STRÖND CLOUD GROW KALUA	Shaped (SP)	33219 U55
	STRÖND OAT GROW HONEY	Shaped (SP)	33220 U55
	STRÖND DOLPHIN GROW PORTO	Shaped (SP)	33221 U55

COMPLEMENTARY PIECES PIEZAS COMPLEMENTARIAS

S.K.I. S.K.D.

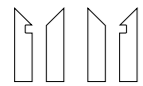

8x30 cm
3.1x11.8 "

SKIRTING

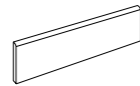

8x75,5 cm 3.1x29.7 "
8x90 cm 3.1x35.4 "
8x60 cm 3.1x23.6 "

Shaped (SP)	U53	Shaped (SP)	U45	U44	U35
Antislip (A)	U53	Antislip (A)	-	U44	-

STAIR TREADS

TECHNICAL (PT) SEAMLESS (PL/18)

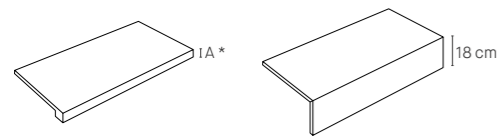

30x180 cm 11.8x70.8 "
30x120 cm 11.8x47.2 "
30x100 cm 11.8x39.4 "
30x90 cm 11.8x35.4 "
30x60 cm 11.8x23.6 "

Shaped (SP)	U90	U75	U74	U76	U54
Antislip (A)	-	-	-	U76	-

* When thickness is 6 mm, A = 18 mm; when 8 mm, then A = 24 mm; when 10 mm, then A = 30 mm.
* Cuando el espesor es 6 mm, A = 18 mm; cuando es 8 mm, A = 24 mm; cuando es 10 mm, A = 30 mm.

POOL PIECES PIEZAS DE PISCINA

Porcelain Porcelánico

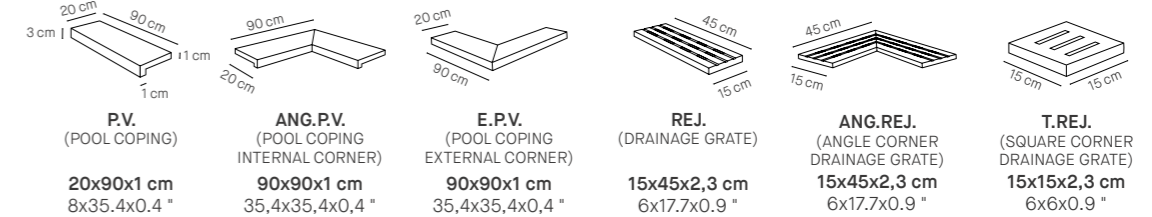

CLOUD	Antislip (A)	33877 U81	33880 U75	33883 U75	33886 U54	33895 U75	33898 U71
OAT	Antislip (A)	33879 U81	33882 U75	33885 U75	33894 U54	33897 U75	33899 U71
DOLPHIN	Antislip (A)	33878 U81	33881 U75	33884 U75	33893 U54	33896 U75	33900 U71

20 mm thickness 20 mm de espesor

Porcelain Porcelánico

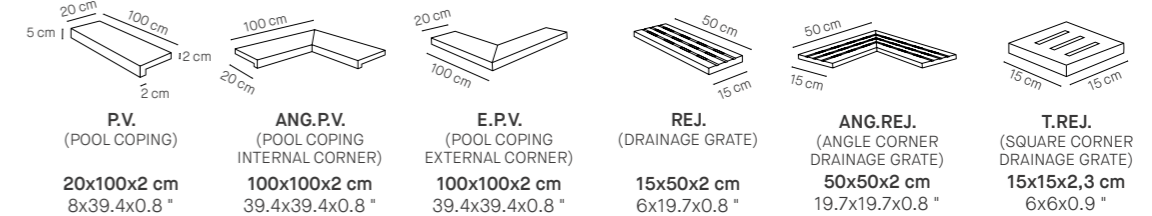

CLOUD	Antislip (A)	35502 U82	35505 U86	35508 U86	35514 U54	35524 U86	35527 U71
OAT	Antislip (A)	35503 U82	35506 U86	35509 U86	35516 U54	35526 U86	35529 U71
DOLPHIN	Antislip (A)	35504 U82	35507 U86	35510 U86	35515 U54	35525 U86	35528 U71

SUBLIME

SUBLIME is inspired by the innate spirituality of nature, from the own aesthetic of outdoors to the intimate observations and reflections of a traveller. SUBLIME presents a wide range of designs that can be combined with each other, and together or individually can bring extraordinary beauty to the spaces. The collection has four different graphics: Iceberg —*Camouflage White or Terre di Bolgheri* marble—, Thunder —*Negresco Grey* marble—, Vulcano —*Calacatta Black* marble— and Cliff —*Oreo Grey* stone—. With SUBLIME, MUSEUM is committed to a new collection concept, where it launches four different graphics that can be combined with each other, to surprise aesthetically both by combining them and independently. They are graphics with a lot of personality, especially the Cliff graphic, which denotes prominence wherever it is.

SUBLIME se inspira en la espiritualidad innata de la naturaleza, desde la estética propia del entorno al aire libre, hasta las observaciones y reflexiones íntimas de un viajero. SUBLIME presenta una amplia gama de diseños combinables entre sí, que en conjunto o individualmente aportan una extraordinaria belleza al espacio. La colección tiene cuatro diferentes gráficas: Iceberg —*mármol Camouflage White o Terre di Bolgheri*—, Thunder —*mármol Negresco Grey*—, Vulcano —*mármol Calacatta Black*— y Cliff —*pétreo Oreo Grey*—. Con SUBLIME, MUSEUM apuesta por un nuevo concepto de colección, donde lanza cuatro gráficas distintas combinables entre sí, para sorprender estéticamente tanto combinándolas como de forma independiente. Son gráficas con mucha personalidad, especialmente la gráfica Cliff, que denota protagonismo allá donde esté.



COLOURS

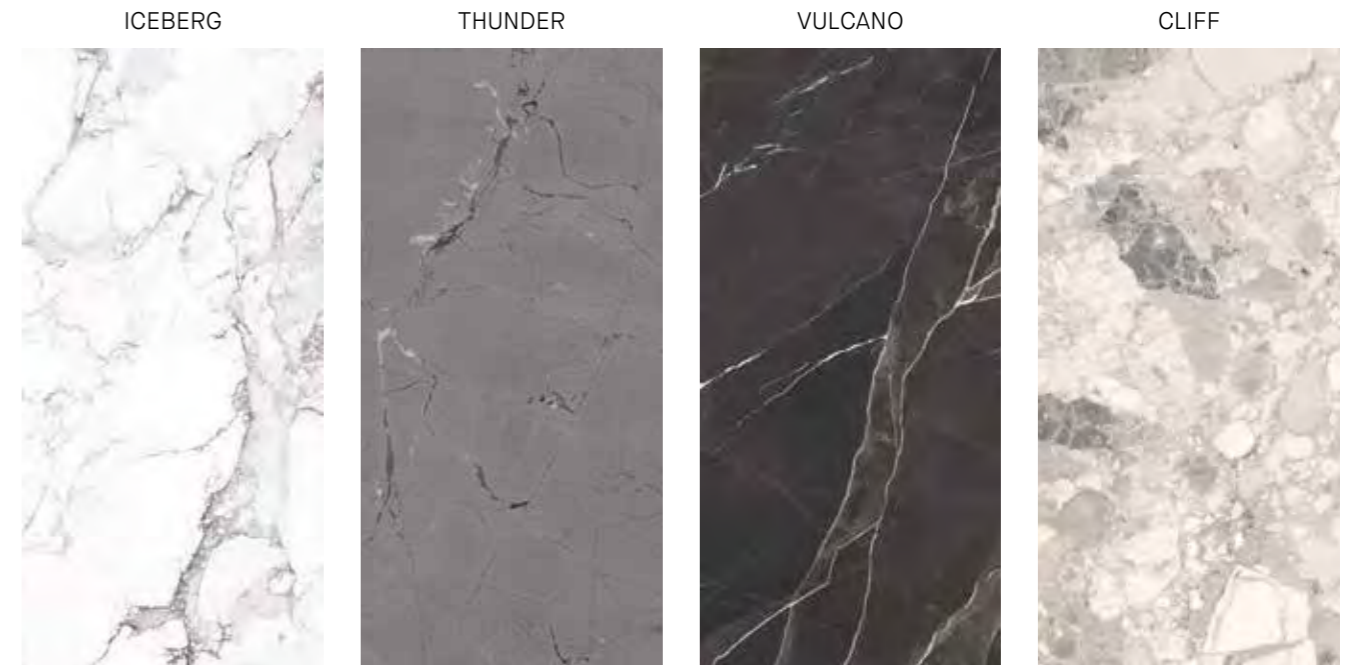

FINISHES

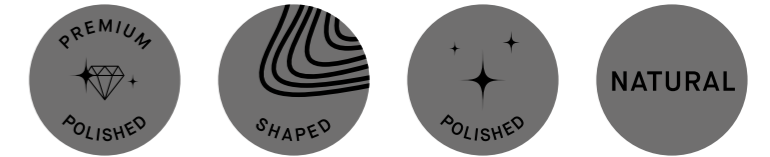

FORMATS

150x320 cm available (ELEVATE WORKTOPS).
Disponibile 150x320 cm (ELEVATE WORKTOPS).

Special Pieces Piezas Especiales

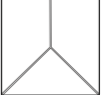
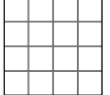
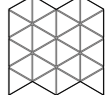
D. MIX	D. MOSAIC	D. TRIANGLE
30x30 cm 11.8x11.8 "	30x30 cm 11.8x11.8 "	29x29 cm 11.4x11.4 "
		

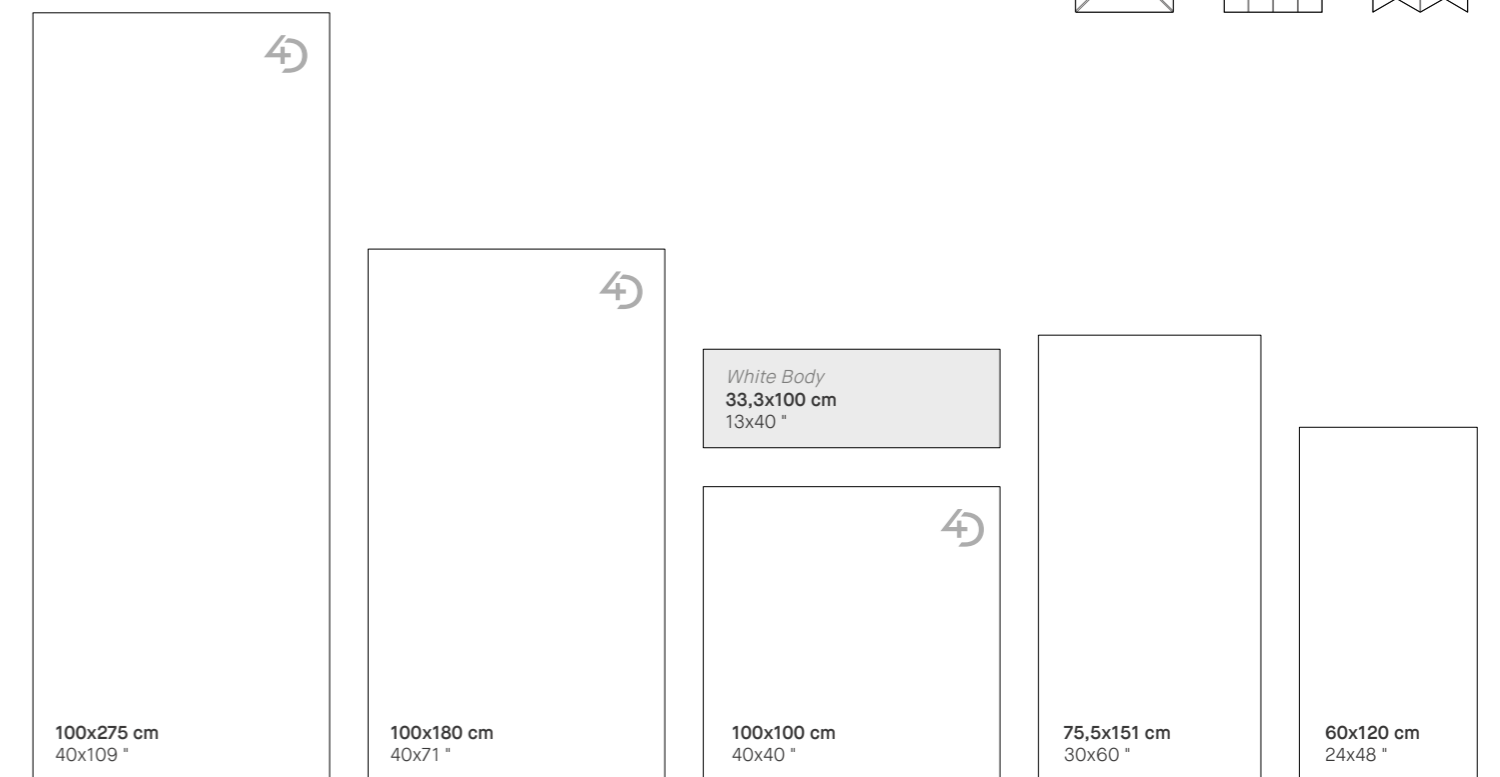

- 01. **■** SUBLIME ICEBERG SP/150X320 **■** ICEBERG SP/100X275/R & VULCANO NT/75,5X151/C/R **■** THUNDER SP/100X100/R
- 02. SUBLIME VULCANO NT
- 03. SUBLIME THUNDER SP
- 04. Conceptual space "GEODAZZLE" designed by EstudiHac at Casa Decor 2023. Photography: Luis Hevia.
- 05. SUBLIME CLIFF close-up.



Scan and discover GROW:
Escanee y descubra GROW:







07.

- 06. ■ SUBLIME ICEBERG SP/100X275/R & THUNDER SP/100X275/R ■ SUBLIME ICEBERG SP/100X100/R ■ SUBLIME CLIFF SP/150X320
- 07. ■ SUBLIME ICEBERG SP/33X100/R & SUBLIME ICEBERG DECOR SP/33X100/R
- 08. ■ SUBLIME ICEBERG DECOR SP/33X100/R



08.



10.



- 09. ■ SUBLIME THUNDER 100X275/P & CLIFF 100X275/P ■ ICEBERG SP/100X100/R
- 10. ■ ICEBERG SP/150X320 MUSEUM BATH SUBLIME ICEBERG PRIMARY 160/SS ■ SUBLIME CLIFF SP/100X275/R
- 11. SUBLIME CLIFF SP

11.







PATTERNS VARIETY VARIEDAD GRÁFICA SUBLIME ICEBERG 100x180 cm FORMAT SUBLIME ICEBERG FORMATO 100x180 cm

FORMATS FORMATOS

		Porcelain Porcelánico				White Body Pasta Blanca		
		100x275 cm 40x109"	100x180 cm 40x71"	100x100 cm 40x40"	75,5x151 cm 30x60"	60x120 cm 24x48"	33,3x100 cm 13x40"	33,3x100 cm 13x40"
		DECOR						
Thickness Espesor		6 mm	8 mm		10 mm		10,5 mm	13,5 mm
Patterns Gráficas		5	9	15	15	20	25	25
ICEBERG	Premium Polished (P)	36267 M87	-	-	-	-	-	-
	Shaped (SP)	36262 M100	36141 M94	36142 M93	-	-	36263 M96	36261 M97
	Polished (EP)	-	-	-	36190 M58	36192 M40	-	-
	Natural (NT)	-	-	-	36161 M103	36193 M101	-	-
THUNDER	Premium Polished (P)	36268 M87	-	-	-	-	-	-
	Shaped (SP)	36264 M95	36257 M94	36250 M93	-	-	36272 M96	36271 M97
	Polished (EP)	-	-	-	36243 M58	36239 M40	-	-
	Natural (NT)	-	-	-	36247 M103	36236 M101	-	-
VULCANO	Premium Polished (P)	36269 M88	-	-	-	-	-	-
	Polished (EP)	-	-	-	36244 M74	36240 M73	-	-
	Natural (NT)	-	-	-	36248 M103	36235 M101	-	-
CLIFF	Premium Polished (P)	36270 M87	-	-	-	-	-	-
	Shaped (SP)	36266 M100	36256 M94	36251 M93	-	-	-	-

TECHNICAL DATA DATOS TÉCNICOS



	DIN 51130	DIN 51097	UNE-41901 EX	BS 7976-2 (PTV)	ANSI A137.1 (DCOF)
Shaped (SP) 6-8 mm	-	-	Class 1	-	>0,42
Natural (NT)	R10	A + B	Class 2	+36 Wet	>0,42

SPECIAL PIECES PIEZAS ESPECIALES

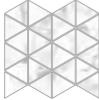

Porcelain Porcelánico (10 mm)

* D. MIX 30x30 cm 11.8x11.8 "			
	ICEBERG THUNDER VULCANO	Natural (NT)	36858 U51
	ICEBERG THUNDER VULCANO	Polished (EP)	36860 U51

White Body Pasta Blanca (10,5 mm)

** D. TRIANGLE 29x29 cm 11.4x11.4 "			
	ICEBERG	Shaped (SP)	36861 U53
	THUNDER	Shaped (SP)	36862 U53

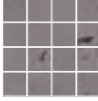
Porcelain Porcelánico (10 mm)

D. MOSAIC 30x30 cm 11.8x11.8 "			
	ICEBERG	Natural (NT)	36850 U36
		Polished (EP)	36851 U36
	THUNDER	Natural (NT)	36852 U36
		Polished (EP)	36853 U36
	VULCANO	Natural (NT)	36854 U36
		Polished (EP)	36855 U36

* Random colour position.
* Posición de colores aleatoria.

** Only suitable for wall installations.
** Adecuado únicamente como revestimiento.

COMPLEMENTARY PIECES PIEZAS COMPLEMENTARIAS

S.K.I. S.K.D.

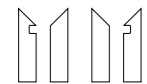

8x30 cm
3.1x11.8 "

SKIRTING

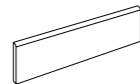

8x100 cm 8x75,5 cm 8x60 cm
3.1x39.4 " 3.1x29.7 " 3.1x23.6 "

Premium Polished (P)	U53	Premium Polished (P)	U48	-	-
Shaped (SP)	U53	Shaped (SP)	U45	-	-
Polished (EP)	U53	Polished (EP)	-	U43	U35
Natural (NT)	U53	Natural (NT)	-	U43	U35

STAIR TREADS

TECHNICAL (PT) SEAMLESS (PL/18)

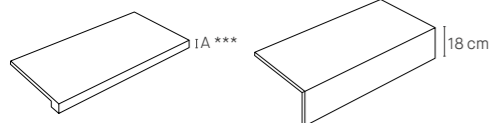

30x180 cm 30x151 cm 30x120 cm 30x100 cm 30x75,5 cm 30x60 cm
11.8x70.8 " 11.8x59.4 " 11.8x47.2 " 11.8x39.4 " 11.8x29.7 " 11.8x23.6 "

Premium Polished (P)	U90	-	-	U74	-	-
Shaped (SP)	U90	-	-	U74	-	-
Polished (EP)	-	U86	U75	-	U76	U54
Natural (NT)	-	U86	U75	-	U76	U54

*** When thickness is 6 mm, A = 18 mm; when 8 mm, then A = 24 mm; when 10 mm, then A = 30 mm.
*** Cuando el espesor es 6 mm, A = 18 mm; cuando es 8 mm, A = 24 mm; cuando es 10 mm, A = 30 mm.

13. SUBLIME THUNDER DECOR SP/33,3X100/R & THUNDER SP/33,3X100/R



SUPREME

SUPREME is a collection that unites stylish elegance with a strong design appeal. Inspired by select pieces of *Invisible Blue* marble, its bluish-grey surface veining contrasts with the white background, lending each of the tiles a personality more synonymous with a work of art.

Available in 4D TECH in a 100x275 cm Shaped finish, and 100x180 cm Premium Polished and Shaped finishes and 100x100 cm Shaped finish. Also available in a Polished or Natural finish in 60x120 cm or 75,5x151 cm format.

SUPREME is perfect for creating settings conceived to make a unique, highly original impact, elevating the concept of deluxe sophistication to new levels.

SUPREME es la colección donde el diseño y la elegancia se aúnan para sorprendernos. Inspirada en la versión más exclusiva del mármol *Invisible Blue*, representa una superficie de tonos grises azulados, que contrastan sobre su base blanca, proporcionándole carácter y personalidad a cada una de sus piezas, como si de una obra de arte se tratara.

Disponible en 4D TECH, en formato 100x275 acabado Shaped, 100x180cm acabado Shaped y Premium Polished, y 100x100cm en acabado Shaped. Y también disponible en acabado Pulido y Natural en formatos 60x120 cm y 75,5x151 cm.

En definitiva, SUPREME es una apuesta ideal para crear espacios únicos y excepcionales, donde lujo y sofisticación alcanzan su máxima expresión.



01.

COLOURS

WHITE



FINISHES

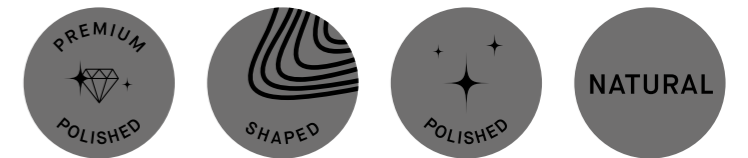



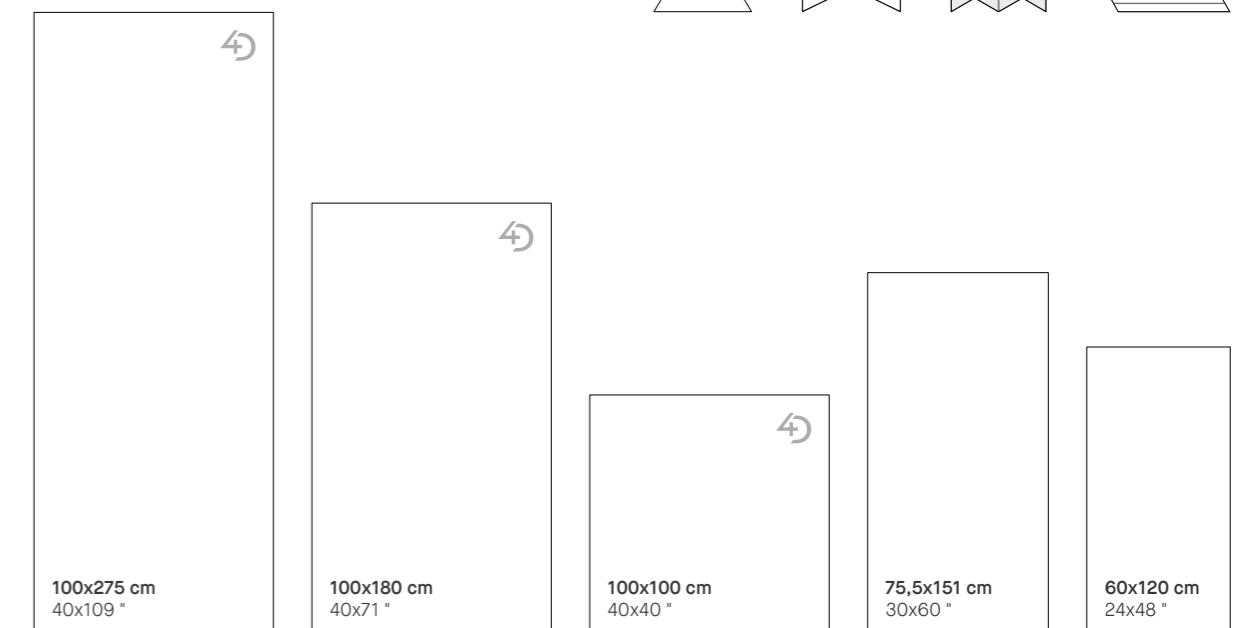

FORMATS

Special Pieces Piezas Especiales

TRI.	D. CHEVRON	D. TRIANGLE	D. ARR
29,9x25,7 cm 11.8x10.1"	30x21,9 cm 11.8x8.6"	White Body 29x29 cm 11.4x11.4"	14,6x51 cm 5.7x20.1"



- 01.  &  SUPREME WHITE/100X180/P
- 02. SUPREME WHITE SP/100X180/R in Ca'rabasseta private housing designed by Dobleese Estudio. Photography: María Mira.
- 03.  &  SUPREME WHITE SP/100X180/R
- 04. D. SUPREME WHITE/KALUA CHEVRON/30X21
- 05. SUPREME WHITE close-up







Scan and discover SUPREME:
Escanee y descubre SUPREME:





07.



- 06.  SUPREME WHITE SP/100X275/R
- 07.  &  SUPREME WHITE SP/100X180/R
- 08.  SUPREME WHITE SP/100X180/R

08.







PATTERNS VARIETY VARIEDAD GRÁFICA SUPREME WHITE 100x180 cm FORMAT SUPREME WHITE FORMATO 100x180 cm

FORMATS FORMATOS

		Porcelain Porcelánico				
		100x275 cm 40x109 "	100x180 cm 40x71 "	100x100 cm 40x40 "	75,5x151 cm 30x60 "	60x120 cm 24x48 "
Thickness Espesor		6 mm	8 mm		10 mm	
Patterns Gráficas		5	8	10	10	15
WHITE	Premium Polished (P)	-	27513 M76	-	-	-
	Shaped (SP)	35463 M100	27512 M94	27511 M93	-	-
	Polished (EP)	-	-	-	27329 M58	27327 M40
	Natural (NT)	-	-	-	27330 M59	27328 M66

TECHNICAL DATA DATOS TÉCNICOS

	DIN 51130	DIN 51097	UNE-41901 EX	BS 7976-2 (PTV)	ANSI A137.1 (DCOF)
Natural (NT)	-	-	Class 1	-	-
Shaped (SP)	-	-	Class 1	-	>0,42

	100x275 cm 40x109 "	100x180 cm 40x71 "
WallPEC		
Premium Polished (P) & Shaped (SP)	E3 C2	E3 C2

SPECIAL PIECES PIEZAS ESPECIALES

Porcelain Porcelánico (10 mm)

TRI.	29,9x25,7 cm 11.8x10.1 "		
	WHITE	Polished (EP)	27807 U34
		Natural (NT)	27814 U34

Porcelain Porcelánico (10 mm)

** D. ARR. 1	14,6x51 cm 5.7x20.1 "		
	SUPREME WHITE MARQUINA BLACK	Polished (EP)	27874 U51
		** D. ARR. 2	
	SUPREME WHITE MARQUINA BLACK	Polished (EP)	27875 U51

Porcelain Porcelánico (10 mm)

* D. TRIANGLE	29x29 cm 11.4x11.4 "		
	WHITE	Natural (NT)	37644 U58

Porcelain Porcelánico (10 mm)

D. CHEVRON	30x21,9 cm 11.8x8.6 "		
	SUPREME WHITE GROW KALUA	Polished (EP)	27862 U55
		Shaped (SP)	

* Only suitable for wall installations.
* Adecuado únicamente como revestimiento.

** 1 m² composition = 14 pieces
(7 pieces D.ARR 1 + 7 pieces D.ARR 2) aproximately.
** Composición 1 m² = 14 piezas
(7 piezas D.ARR 1 + 7 piezas D.ARR 2) aproximadamente.

COMPLEMENTARY PIECES PIEZAS COMPLEMENTARIAS

S.K.I. S.K.D.



8x30 cm
3.1x11.8 "

SKIRTING

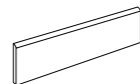

8x100 cm 3.1x39.4 "
8x75,5 cm 3.1x29.7 "
8x60 cm 3.1x23.6 "

Premium Polished (P)	U53	Premium Polished (P)	U48	-	-
Polished (EP)	U53	Polished (EP)	-	U43	U35
Shaped (SP)	U53	Shaped (SP)	U45	-	-
Natural (NT)	U53	Natural (NT)	-	U43	U35

STAIR TREADS

TECHNICAL (PT) SEAMLESS (PL/18)



30x180 cm 11.8x70.8 "
30x151 cm 11.8x59.4 "
30x120 cm 11.8x47.2 "
30x100 cm 11.8x39.4 "
30x75,5 cm 11.8x29.7 "
30x60 cm 11.8x23.6 "

Premium Polished (P)	U90	-	-	U74	-	-
Polished (EP)	-	U86	U75	-	U76	U54
Shaped (SP)	U90	-	-	U74	-	-
Natural (NT)	-	U80	U75	-	U70	U54

*** When thickness is 6 mm, A = 18 mm; when 8 mm, then A = 24 mm; when 10 mm, then A = 30 mm.
*** Cuando el espesor es 6 mm, A = 18 mm; cuando es 8 mm, A = 24 mm; cuando es 10 mm, A = 30 mm.

10. ■ D. SUPREME WHITE TRIANGLE/29X29



TORANO

The TORANO collection comes in widely assorted formats and finishes to ensure high design potential. Its select design is inspired by Calacatta marble from the Carrara area: a marble with a white background covered in bold veins, more dramatic than Carrara marble's grey background and gentle veining.

Torano comes in two finishes, a Polished or a Natural one, in a choice of two colours, Bianco and Gold, both in a 75,5x151 cm, 60x120 cm or 90x90 cm format.

La colección TORANO en formatos y acabados diferentes para ganar en versatilidad. Su exclusiva gráfica se inspira en el mármol *Calacatta* proveniente de la zona de Carrara. Es un mármol que se distingue por su fondo blanco y vetas fuertes. Más dramático que un Carrara, que por el contrario suele ser más gris de fondo con vetas más suaves.

Disponibile en los acabados Pulido y Natural, en dos colores Bianco y Gold. Ambos en los formatos 75,5x151 cm, 60x120 cm y 90x90 cm.



COLOURS

BIANCO



GOLD



FINISHES



FORMATS

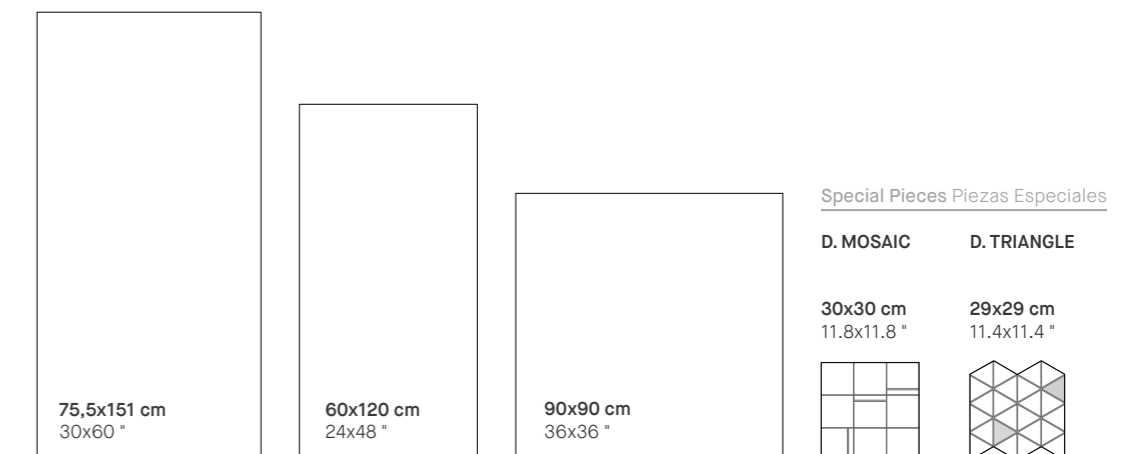

- 01. ■ TORANO BIANCO NT/75,5X151/R
- 02. ■ TORANO GOLD NT/75,5X151/R
- 03. ■ TORANO BIANCO NT/60X120/R ■ TORANO BIANCO EP/60X120/R
- 04. ■ D. TORANO BIANCO TRIANGLE/29X29/R
- 05. TORANO BIANCO close-up



Scan and discover TORANO:
Escanee y descubra TORANO:





07.



06. ■ TORANO BIANCO/75,5X151/EP ■ TORANO BIANCO/75,5X151/NAT/R

07. ■ TORANO GOLD NT/60X120/R ■ TORANO GOLD EP/75,5X151/R

08. ■ TORANO GOLD/75,5X151/EP

08.





PATTERNS VARIETY VARIEDAD GRÁFICA TORANO BIANCO 90x90 cm FORMAT TORANO BIANCO FORMATO 90x90 cm

FORMATS FORMATOS

		Porcelain Porcelánico		
		75,5x151 cm 30x60 "	60x120 cm 24x48 "	90x90 cm 36x36 "
Thickness Espesor		10 mm		
Patterns Gráficas		40	40	20
BIANCO	Polished (EP)	21070 M58	22011 M40	25173 M2
	Natural (NT)	21074 M59	22012 M66	25980 M68
GOLD	Polished (EP)	27281 M58	27275 M40	27832 M2
	Natural (NT)	27283 M59	27282 M66	27831 M68

SPECIAL PIECES PIEZAS ESPECIALES

Porcelain Porcelánico (10 mm)

* D. MOSAIC 30x30 cm 11.8x11.8 "

	BIANCO	Polished (EP) & Natural (NT)	22252 U58
	GOLD	Polished (EP) & Natural (NT)	27316 U58

Porcelain Porcelánico (10 mm)

* D. TRIANGLE 29x29 cm 11.4x11.4 "

	BIANCO	Polished (EP)	26363 U58
		Natural (NT)	30083 U58
	GOLD	Polished (EP)	30085 U58
		Natural (NT)	30084 U58

* Only suitable for wall installations.
* Adecuado únicamente como revestimiento.

COMPLEMENTARY PIECES PIEZAS COMPLEMENTARIAS

S.K.I. S.K.D.		SKIRTING			
8x30 cm 3.1x11.8 "		8x90 cm 3.1x35.4 "	8x75,5 cm 3.1x29.7 "	8x60 cm 3.1x23.6 "	
Polished (EP)	U53	Polished (EP)	U44	U43	U35
Natural (NT)	U53	Natural (NT)	U44	U43	U35
STAIR TREADS					
TECHNICAL (PT)		SEAMLESS (PL/18)			
	13 cm		18 cm		
30x151 cm 11.8x59.4 "		30x120 cm 11.8x47.2 "	30x90 cm 11.8x35.4 "	30x75,5 cm 11.8x29.7 "	30x60 cm 11.8x23.6 "
Polished (EP)		U86	U75	U76	U76
Natural (NT)		U80	U75	U76	U70

TECHNICAL DATA DATOS TÉCNICOS

	DIN 51130	DIN 51097	UNE-41901 EX	BS 7976-2 (PTV)	ANSI A137.1 (DCOF)
Natural (NT)	-	-	Class 1	-	>0,42

WISTMAN OAK

WISTMAN is an oak wood-effect collection conspicuous for its timeless beauty, with a highly natural 'Versailles' marquetry pattern. It can be used to create settings of widely differing kinds, depending on whether it is used alone or in combination with other kinds of tile collections, such as white marble or textured stone-effect tiles.

WISTMAN OAK comes in a 90x90 cm format in four natural warm colours: Maple, Honey, Mocha and Cognac, designed to infuse living spaces with a warm contemporary appeal.

WISTMAN OAK representa el efecto madera de roble aplicado en una marquetería 'estilo Versailles', muy natural, decorativa y atemporal. Ofrece la posibilidad de crear espacios diversos según si se aplica el producto de forma única o combinado con otras tipologías como pueden ser los mármoles blancos o productos pétreos texturados.

Sus tonos cálidos, aportan un estilo acogedor y contemporáneo, a la vez que elegante. Se encuentra disponible en formato 90x90 cm, y en cuatro tonos naturales: Maple, Honey, Mocha y Cognac.



COLOURS

MAPLE



HONEY



MOCHA



COGNAC







FINISHES

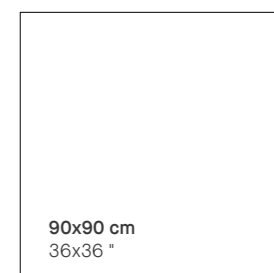

FORMATS



- 01.  WISTMAN COGNAC NT/90X90/R
- 02.  WISTMAN MOCHA NT/90X90/R
- 03.  WISTMAN COGNAC NT/90X90/R
- 04.  WISTMAN COGNAC NT/90X90/R
- 05. WISTMAN HONEY close-up



Scan and discover WISTMAN OAK:
Escanee y descubra WISTMAN OAK:





07.



- 06. ■ WISTMAN MOCHA NT/90X90/R
- 07. ■ WISTMAN MAPLE NT/90X90/R ■ CALACATTA EXTRA WHITE/100x275/P
- 08. WISTMAN MAPLE NT

08.



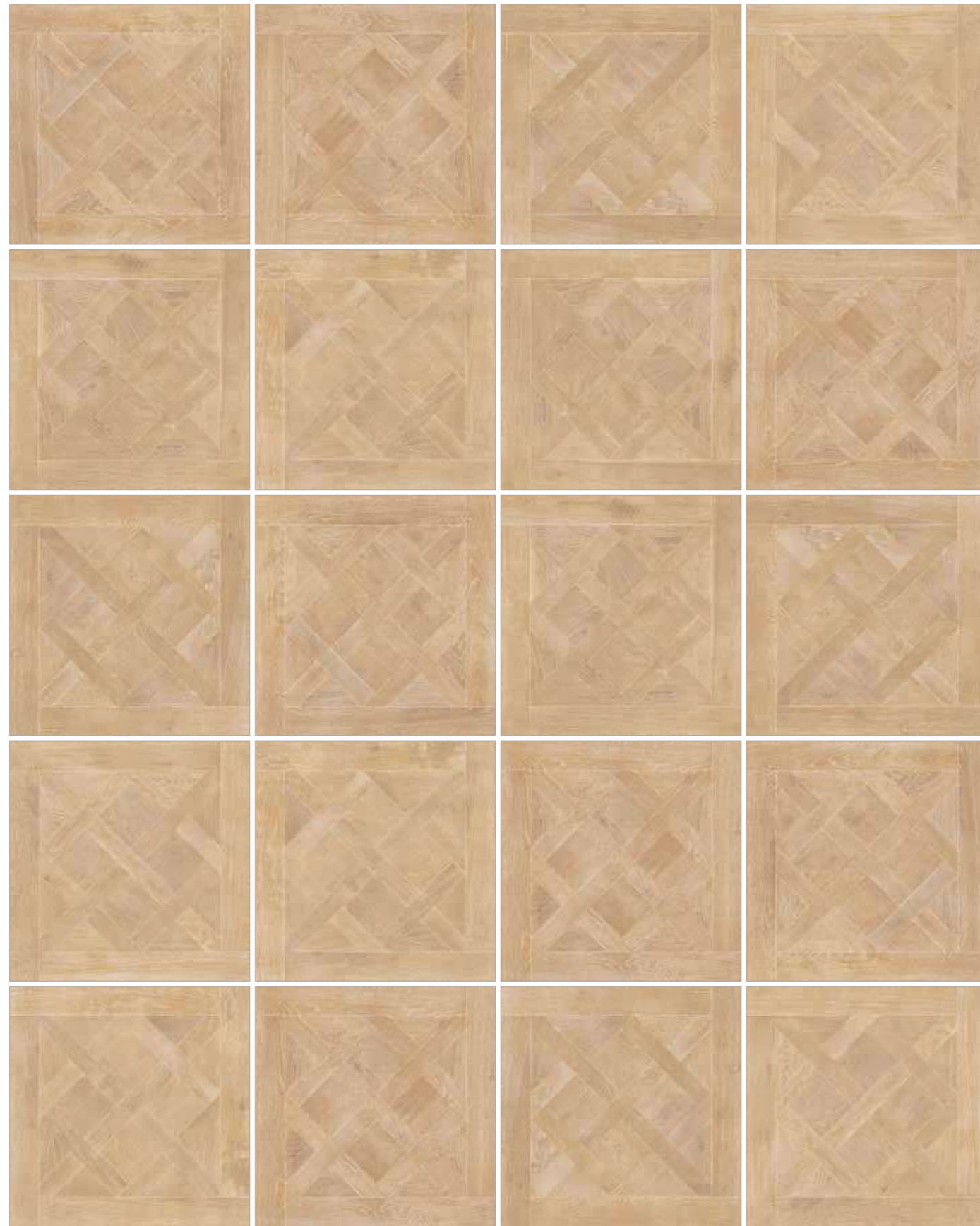

PATTERNS VARIETY VARIEDAD GRÁFICA WISTMAN OAK HONEY 90x90 cm FORMAT WISTMAN OAK HONEY FORMATO 90x90 cm

FORMATS FORMATOS

		Porcelain Porcelánico
		90x90 cm 36x36 "
Thickness Espesor		10 mm
Patterns Gráficas		6
MAPLE	Natural (NT)	25931 M81
HONEY	Natural (NT)	25930 M81
MOCHA	Natural (NT)	25932 M81
COGNAC	Natural (NT)	25933 M81

TECHNICAL DATA DATOS TÉCNICOS

	DIN 51130	DIN 51097	UNE-41901 EX	BS 7976-2 (PTV)	ANSI A137.1 (DCOF)
Natural (NT)	R10	-	Class 1	+36 Wet	>0,42

MUSEUM BATH















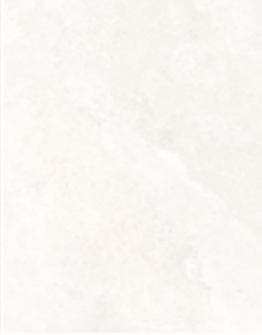





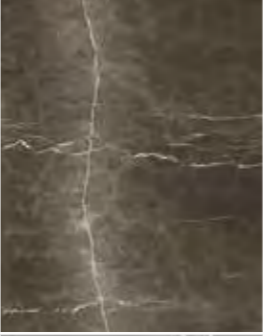

MUSEUM aspires to help create unique exclusive settings, developing products conceived to meet consumer needs and to fit in with the latest trends. With this in mind, we have created an extensive range of washbasin units with a strong design appeal, bringing the very essence of MUSEUM to a selection of exclusive models.

The minimalist design with the versatile character of these new sinks makes them ideal for its integration in space. Models that combine design and functionality adapting to the needs of each bathroom.

El deseo de MUSEUM es llegar a ofrecer espacios únicos y exclusivos, desarrollando proyectos que se adapten a las necesidades del cliente y que reflejen las nuevas tendencias. Para ello, apostamos por crear una amplia gama de baño con elementos de diseño, llevando la esencia de MUSEUM a diferentes y exclusivas composiciones.

El diseño minimalista junto al carácter versátil de estos nuevos lavabos favorece su integración en el espacio. Modelos que combinan diseño y funcionalidad adaptándose a las necesidades de cada baño.

<p>arte cloud</p> <p>SHAPED</p> 	<p>arte desert</p> <p>SHAPED</p> 	<p>arte mocha</p> <p>SHAPED</p> 										
 <p>calacatta white</p> <p>NATURAL</p>	 <p>calacatta gold</p> <p>NATURAL</p>	 <p>chicago cloud</p> <p>SHAPED</p>	 <p>chicago mocha</p> <p>SHAPED</p>	 <p>chicago road</p> <p>SHAPED</p>	 <p>chicago moon</p> <p>SHAPED</p>							
 <p>praliné white</p> <p>SHAPED</p>	 <p>dual white</p> <p>SHAPED</p>	 <p>haute white</p> <p>SHAPED</p>	 <p>kron gray</p> <p>NATURAL</p>	 <p>kron charcoal</p> <p>NATURAL</p>	 <p>premiere white</p> <p>SHAPED</p>							
 <p>strönd cloud</p> <p>SHAPED</p>	 <p>strönd oat</p> <p>SHAPED</p>	 <p>strönd dolphin</p> <p>SHAPED</p>	 <p>sublime iceberg thunder cliff</p> <p>SHAPED</p>	 <p>supreme white</p> <p>SHAPED</p>								

The variety of MUSEUM collections promotes the customization of washbasins. You can choose from a wide range of 6mm thick products, in Shaped and Natural finishes.

La variedad de colecciones MUSEUM favorece la personalización de los lavabos. Puede elegir entre una gran diversidad de productos de 6 mm de espesor, en los acabados Shaped y Natural.









PRIMARY

160

120

80

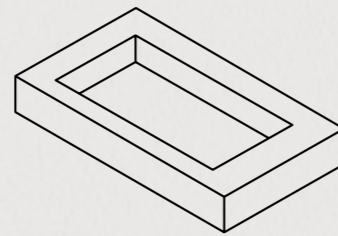
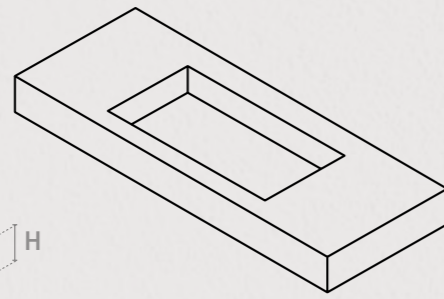
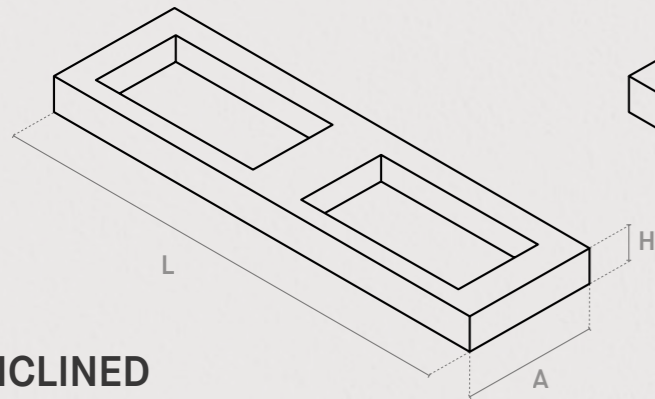

INCLINED

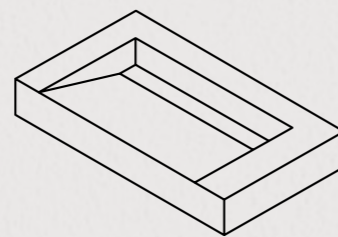
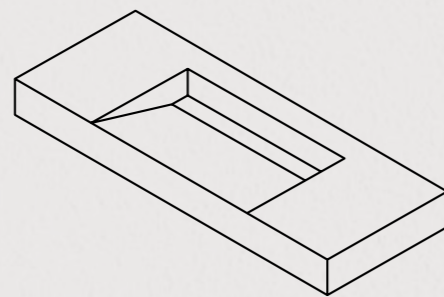
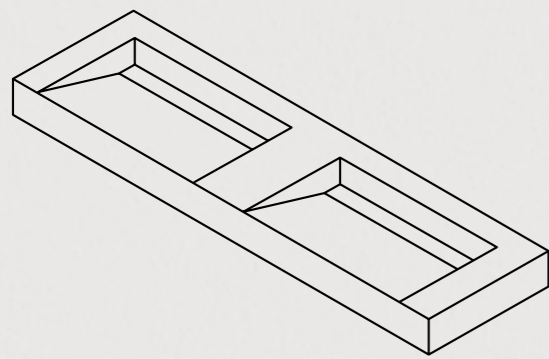

TOTAL MEASURES (LxA×H)
MEDIDAS TOTALES (LxA×H)

1600 x 455 x 120 mm
1600 x 455 x 120 mm

1200 x 455 x 120 mm
1200 x 455 x 120 mm

800 x 455 x 120 mm
800 x 455 x 120 mm

SINK OPTIONS
OPCIONES DE SENO

2 sinks (SS)
2 senos (SS)

1 sink (SI/SC/SD)
(location can be chosen)
1 seno (SI/SC/SD)
(posición elegible)

1 sink (SC)
1 seno (SC)

TAP OPTIONS
OPCIONES DE GRIFO

Custom holes
(tap not included)
Agujeros a medida
(grifo no incluido)

Custom holes
(tap not included)
Agujeros a medida
(grifo no incluido)

Custom holes
(tap not included)
Agujeros a medida
(grifo no incluido)

MOUNTING BRACKETS
ESCUADRAS DE MONTAJE

4 brackets
4 escuadras

2 brackets
2 escuadras

2 brackets
2 escuadras

PRICE RATES
CÓDIGOS DE PRECIO
(without brackets set)
(sin juego de escuadras)

MB1
MB1

MB2
MB2

MB3
MB3

(with brackets set)
(con juego de escuadras)

MB4
MB4

MB5
MB5

MB6
MB6

Sink Options Opciones de seno

In both PRIMARY and INCLINED 120 models, the sink location can be chosen: left (SI), center (SC) or right (SD). 160 models have always two sinks (SS). 80 models have always one centered sink (SC).

En los modelos 120, tanto PRIMARY como INCLINED, se puede elegir la posición del seno: a la izquierda (SI), centrado (SC) o a la derecha (SD). Los modelos 160 siempre tienen doble seno (SS). Los modelos 80 siempre tienen un seno centrado (SC).

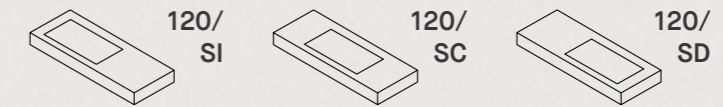

Mounting Brackets Escuadras de montaje

If desired, MUSEUM BATH can be installed suspended on the wall using wall mount brackets. For the correct installation, it is recommended taking into account the approximate furniture weights indicated. We provide the mounting brackets for an additional fee (1 set = 2 wall mount brackets). 160 model requires 2 sets, while 120 and 80 models require only 1 set.

Si lo desea, MUSEUM BATH puede instalarse suspendido en pared usando escuadras de montaje para pared. Para la correcta instalación, se recomienda tener en cuenta los pesos aproximados del mueble. Proporcionamos las escuadras con una tarifa adicional (1 juego = 2 escuadras de montaje para pared). El modelo 160 necesita 2 juegos, mientras que los modelos 120 y 80 necesitan solamente 1 juego.

TOTAL MEASURES (L×H×A)
MEDIDAS TOTALES (L×H×A)

433 x 100 x 90 mm
433 x 100 x 90 mm

SET WEIGHT
PESO DEL JUEGO

4,96 lb
2,25 kg

SET PRICE RATE
PRECIO DEL JUEGO

U80
U80

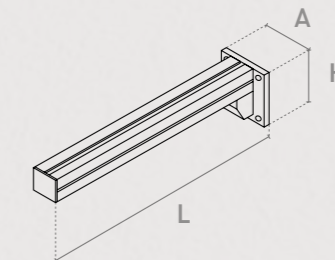

Packing Embalaje

MODEL MODELO	SIZE FORMATO	BOX CAJA		PALLET PALET		
		Piezas	kg	Cajas	kg	Tamaño aprox. cm.
lavabo	mm.					
160	1600 x 455 x 120	1	51	4	204	180 x 90 x 81
120	1200 x 455 x 120	1	46	4	184	120 x 80 x 81
80	800 x 455 x 120	1	33	4	132	120 x 80 x 81
washbasin	inch.	Units	lb	Boxes	lb	Approx. inch. sizes
160	63 x 17.9 x 4.72	1	112.4	4	449.7	70.9 x 35.4 x 31.9
120	47.2 x 17.9 x 4.72	1	101.4	4	405.7	47.3 x 31.5 x 31.9
80	31.5 x 17.9 x 4.72	1	72.8	4	291	47.3 x 31.5 x 31.9

CONSIDERATIONS

Please, read the instructions before installation. Make sure all parts are included and in perfect condition. We highly recommend the installation to be done by qualified personnel. Fixings are not valid for light surfaces such as plywood, drywall, timber wall or similar.

INSTRUCTIONS

1. Mark the spots for the holes on the wall. Make sure they are aligned correctly and proceed drilling.
2. Insert the pegs in the wall holes, put the brackets and screw them on the wall.
3. Put the basin in the right position.
4. Make sure the basin is correctly aligned.
5. To adjust the basin angle, turn the levelling screw located on the low part of the basin until you get the right alignment.
6. Remove the basin and apply silicon along the top side of the brackets. Put the basin back into position and allow it to dry for at least 24 hours.
7. Once dry, remove the levelling screw.

CONSIDERACIONES PREVIAS

Por favor, lea las instrucciones antes de realizar la instalación. Asegúrese de que todas las piezas están incluidas y en perfectas condiciones. Se recomienda que la instalación se realice por personal cualificado. Las fijaciones no son válidas para paredes de contrachapado, pladur o similar.

INSTRUCCIONES

1. Marque la ubicación de los agujeros en la pared a nivel y realice los taladros.
2. Introduzca los tacos en los agujeros de la pared, coloque las escuadras y atornille.
3. Sitúe el lavabo en la posición correcta.
4. Compruebe que el producto está nivelado.
5. Para regular la inclinación del lavabo, gire el tornillo nivelador situado en la parte inferior hasta conseguir su nivelación.
6. Quite el lavabo y aplique un silicona a lo largo de la cara superior de las escuadras. Coloque de nuevo el lavabo y deje secar, al menos 24h.
7. Una vez concluido el periodo de secado, extraiga el tornillo nivelador.

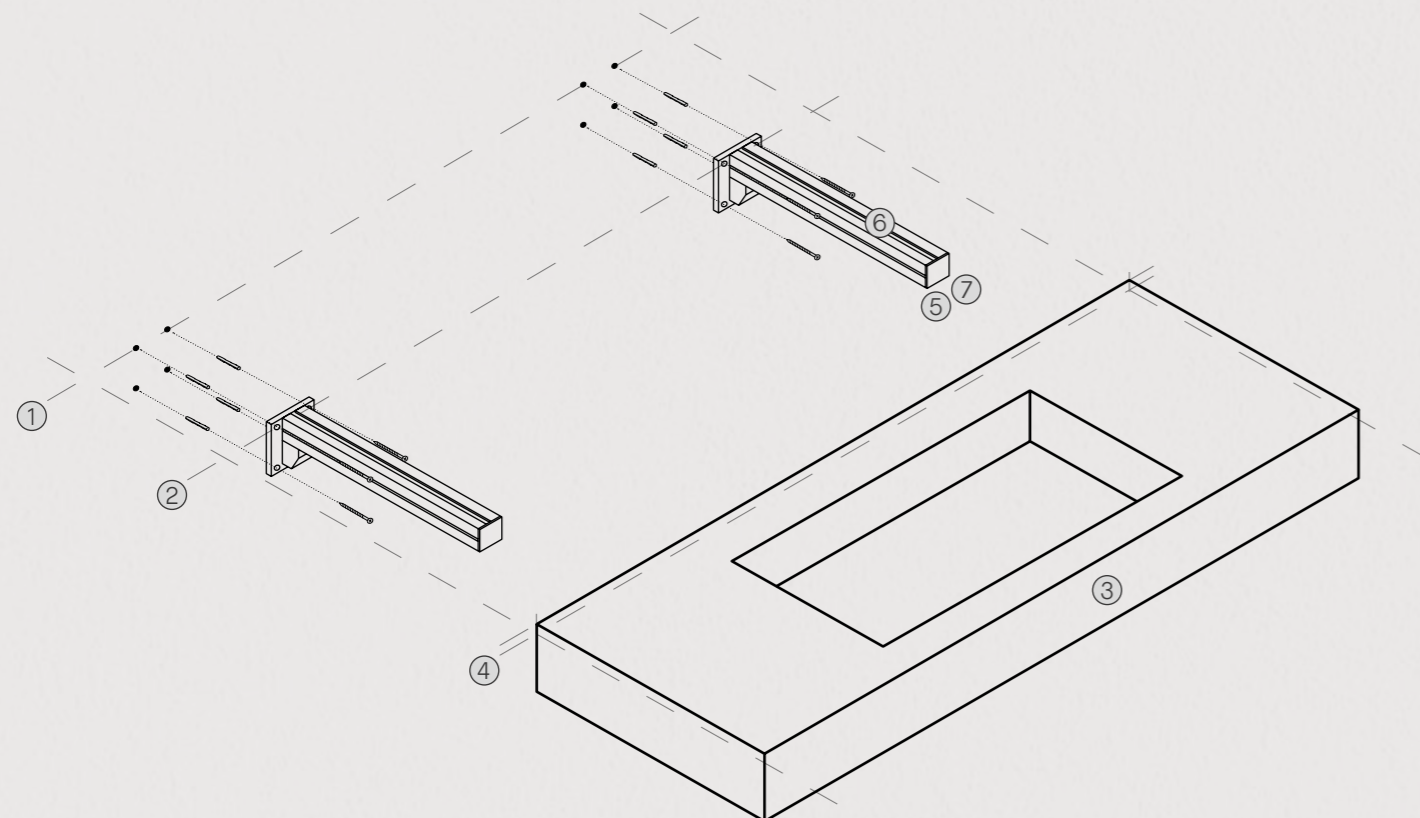

TECHNICAL SPECIFICATIONS

The ceramic washbasins in this ground-breaking collection are made of top-quality porcelain tiles, an optimum choice for bathrooms. This is a forward-looking material, both technologically and in product design terms, thanks to technical properties as fundamental as its water absorption rate, durability and fire resistance. Its mechanical and thermal properties easily surpass the requirements of the relevant standards.

CLEANING

Ceramic surfaces, including basins, require adequate cleaning techniques in order to avoid damaging the surface. We recommend using a washing solution, bioalcohol or a neutral cleaner to get rid of the dirt in the surface. For daily cleaning we recommend using just a damp cloth. It is very important to wipe the surface before applying a cleaning solution of warm water and a soft soap or vinegar. In case that dirt persistently remains in the surface, specific cleaning procedures might be advisable. Gently rubbing with a sponge or a soft cloth in a circular motion will help cleaning persistent stains. For more resistant stains, you can apply a cleaning paste made of water and soda. In any case, high concentrated chemicals and abrasive products should never be used.

ESPECIFICACIONES TÉCNICAS

Los lavabos cerámicos están fabricados en gres porcelánico de primera calidad, un material óptimo para espacios de baño. El uso de dicho material representa un salto hacia el futuro en términos de tecnología y planificación del producto. Se consiguen unas características técnicas perfectas en cuanto a absorción del agua, durabilidad y resistencia contra el fuego. El material presenta unas propiedades mecánicas y térmicas que representan una gran mejora sustancial con respecto a los requisitos exigidos por la normativa en vigor.

LIMPIEZA

Las superficies cerámicas, incluidos los lavabos, requieren técnicas de limpieza adecuadas para evitar dañar la superficie. Se recomienda utilizar una solución de lavado, bioalcohol o limpiador neutro para limpiar la suciedad de las superficies, mientras que para la limpieza diaria se recomienda utilizar un paño ligeramente humedecido. Es importante eliminar la suciedad suelta antes de aplicar una solución limpiadora de agua tibia y un detergente suave o vinagre. Si quedan residuos persistentes en las superficies, pueden ser necesarios procedimientos de limpieza específicos. Frotar suavemente con una esponja suave o un paño con movimientos circulares ayudará a eliminar las manchas difíciles. Para las manchas más resistentes, se puede utilizar una pasta hecha de bicarbonato y agua, pero deben evitarse los productos químicos de muy alta concentración o los materiales abrasivos.



TECHNICAL INFO. INFO. TÉCNICA

- 334. **PACKING**
EMBALAJE
- 336. **HANDLING**
MANIPULADO
- 338. **CLEANING**
LIMPIEZA
- 340. **REGULATION**
NORMATIVA
- 342. **TECHNICAL CHARACTERISTICS**
CARACTERÍSTICAS TÉCNICAS
- 343. **CIRCULAR ECONOMY**
ECONOMÍA CIRCULAR
- 344. **ALPHABETICAL INDEX**
ÍNDICE ALFABÉTICO

FLOOR AND WALL TILES PAVIMENTO Y REVESTIMIENTO

SIZE FORMATO	BOX CAJA			PALLET PALET				CONTAINER 20' (25000 KG.)		
	Piezas	m ²	kg	Cajas	m ²	kg	Tamaño aprox. cm.	Palets	m ²	kg
cm.										
100 x 180 x 0,8	2	3,6	70,88	18	64,8	1326	190 x 115 x 60	17	1101,6	22539,3
100 x 100 x 0,8	2	2	36,8	32	64	1340	112 x 112 x 100	18	1152	24118,6
100 x 100 x 2	1	1	49,2	24	24	1223	112 x 112 x 85	20	480	24456
50 x 100 x 2	1	0,5	24,7	48	24	1228	112 x 112 x 85	20	480	24552
50 x 150 x 0,75	4	3	39,81	24	72	990	156 x 93 x 65	17	1224	16830
75,5 x 151 x 1	1	1,14	26	44	50,16	1179	156 x 93 x 76	17	852,7	20043
24 x 151 x 1	3	1,09	24,27	48	52,32	1200	156 x 93 x 63	17	889,4	20399,3
60 x 120 x 1	2	1,44	33,18	27	38,88	921	120 x 80 x 75	27	1049,8	24836,2
90 x 90 x 1	2	1,62	37,96	22	35,64	860	105 x 95 x 75	29	1033,6	24943,5
33,3 x 100 x 1,05	4	1,33	24	48	63,84	1177	118 x 110 x 81	20	1276,8	23540
33,3 x 100 x 1,35	3	1	21,92	48	48	1077	118 x 110 x 81	20	960	21543,2
inch.	Units	ft ²	lb	Boxes	ft ²	lb	Approx. inch. sizes	Pallets	ft ²	lb
39.4 x 70.8 x 0.35	2	38.75	156.26	18	697.5	2924	71.2 x 44.1 x 25.2	17	11857.5	49691
39.4 x 39.4 x 0.35	2	21.53	81.13	32	688.9	2955	44.1 x 44.1 x 39.4	18	12400	53172.3
39.4 x 39.4 x 0.79	1	10.76	108.47	24	258.3	2696	44.1 x 44.1 x 33.5	20	5166.7	53916.3
19.7 x 39.4 x 0.79	1	5.38	54.45	48	258.3	2708	44.1 x 44.1 x 33.5	20	5166.7	54127.9
19.7 x 59.1 x 0.30	4	32.29	87.76	24	775	2183	61.4 x 36.6 x 25.6	17	13175	37119
29.7 x 59.4 x 0.39	1	12.27	57.32	44	539.9	2600	61.4 x 36.6 x 29.9	17	9178.6	44562
9.45 x 59.4 x 0.39	3	11.73	53.51	48	563.16	2646	61.4 x 36.6 x 24.83	17	9569.1	44840
23.6 x 47.2 x 0.39	2	15.50	73.15	27	418.5	2030	47.2 x 31.4 x 29.5	27	11300	54754.5
35.4 x 35.4 x 0.39	2	17.44	83.68	22	383.6	1896	41.3 x 37.4 x 29.5	29	11125.2	54991
13.11 x 39.4 x 0.41	4	14.32	52.91	48	687.2	2595	46.4 x 43.3 x 31.8	20	13743.4	51897
13.11 x 39.4 x 0.53	3	10.76	48.33	48	516.7	2375	46.4 x 43.3 x 31.8	20	10333.4	47494

SLABS PLACAS

1 SLAB 1 PLACA			WOODEN CRATE CAJÓN MADERA			CONTAINER 20' (25000 KG.)			CONTAINER 40' (25000 KG.)		
cm.	m ²	kg	Placas	m ²	kg	Cajones	m ²	kg	Cajones	m ²	kg
100 x 275 x 0,6	2,75	38,5	20	55	869	24	1320	20856	28	1540	24332
inch.	ft ²	lb	Slabs	ft ²	lb	Crates	ft ²	lb	Crates	ft ²	lb
39,4 x 108,3 x 0,24	29,6	84,88	20	592	1916	24	14208,4	45980	28	16576,4	53643

WOODEN CRATE CAJÓN DE MADERA

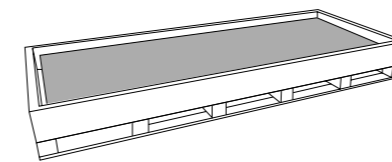

Tamaño aprox. cm.

291 x 112 x 33 cm

Approx. inch. sizes

114.6 x 44 x 13 "

1 SLAB 1 PLACA			A-FRAME CABALLETE			CONTAINER 20' (25000 KG.)			CONTAINER 40' (25000 KG.)		
cm.	m ²	kg	Placas	m ²	kg	Caballete	m ²	kg	Caballete	m ²	kg
100 x 275 x 0,6	2,75	38,5	50	137,5	2024	6	825	12144	11	1512,5	22264
inch.	ft ²	lb	Slabs	ft ²	lb	A-frame	ft ²	lb	A-frame	ft ²	lb
39,4 x 108,3 x 0,24	29,6	84,88	50	1480	4343	6	8880	26058	11	16280	47773

A-FRAME CABALLETE

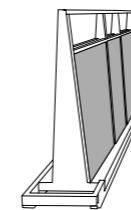

Tamaño aprox. cm.

291 x 150 x 75 cm

Approx. inch. sizes

114.6 x 59 x 29.5 "

handling manipulado

TILE HANDLING RECOMMENDATIONS

- Ceramic tiles should be handled with gloves. Special care and maximum safety precautions should be taken to prevent dropped or broken tiles.
- In the case of large-format tiles, they should be handled and/or moved individually by at least two people. The tiles can be taken out of their packaging by hand or using some kind of lifting frame with suction pads. (If the latter is used, moisten the suction cups first).
- Carry the tiles vertically to prevent them from buckling in the middle.
- To protect the tiles, never rest them directly on the floor or against a wall. Rest them on cork supports or a similar material able to withstand the weight of the tiles.
- Because these are rectified tiles, they must be carefully handled and laid, taking care not to knock them against one another so as to avoid damaging their edges.

CUTTING & DRILLING RECOMMENDATIONS

- The tiles should be cut and/or drilled in well-ventilated conditions. A mask and safety goggles should be worn.
- To avoid problems with the micro-pores in the surface, do not use a pen or marker pen to mark the surface.
- To guarantee perfect cuts or holes, rest the tile on a flat, level, stable work surface. Make sure that it is fully supported.
- For cutting operations, a water-cooled tile saw with a diamond cutting disc should be used. During the cutting process, aim the water jet directly onto the cutting line.
- For drilling operations, to minimize the risk of breaks, first drill a hole in each of the corners of the cut-out to be made. Make sure that the drill is not in hammer mode. Drill bits with a diameter of up to 8mm should be used. Moisten the tile and the tip of the drill bit first or use water-cooled drill bits. Complete the cutting process with a low-powdered radial tile saw, fitted with a diamond cutting disc.

TILE-LAYING, JOINT & TILE ADHESIVE RECOMMENDATIONS

- Before proceeding to lay the tiles, test what they look like on an area of at least 9 m². Tiles should be used from several different boxes to check the overall effect they will make once laid.
- Tiles from the MUSEUM range come with a special wax coating to protect them when they are being handled or laid. This wax coating can easily be removed with a damp cloth. In the event of difficulties in removing it, use a cloth with methylated spirit.
- Make sure that the substrate is completely level and totally clean so as to ensure a firm bond.
- Tile joints of at least the minimum required width should be inserted, as per the following table and uses:

	INDOOR FLOORS	OUTDOOR FLOORS	INDOOR WALLS	FAÇADES
TILE JOINT	>0,5 mm >2 mm for big formats	>0,5 mm >2 mm for big formats	>1,5 mm	>2,5 mm
PERIMETE JOINT	>5 mm	>5 mm	>5 mm	>5 mm
PARTITION JOINT	>5 mm	>5 mm	>5 mm	8-10 mm
STRUCTURAL JOINT	The same as the structural joint in the substrate	The same as the structural joint in the substrate, including a compensation profile or polyurethane beading	The same as the structural joint in the substrate	The same as the structural joint in the substrate, including a 6-35mm compensation profile or polyurethane beading

In the case of the MUSEUM range, because all the tiles are rectified, a minimum joint of 0.5 mm should be left between the tiles. If they are large-format tiles, a joint of 2 mm should be left.

- Tile adhesive with at least a C2 rating should be used. In the case of large formats, the adhesive should also be flexible. Follow the manufacturer's instructions when preparing and using the tile adhesive and grout.
- The thin-bed method should be used, applying the adhesive with a notched trowel, except for large formats when the floating and buttering method will be needed. This consists of spreading the adhesive over the substrate and across the underside of the tile to be laid. Regardless of the technique that is used, make sure that the bonding material or cement-based adhesive is evenly spread across the whole surface.
- To ensure full contact between the tile and the adhesive, tap the surface or press it down with a white rubber mallet, never a black or grey one.
- Use self-levelling tile spacers to avoid unevenly laid tiles, particularly in the case of large-format tiles or staggered rows. Use a tile-levelling gun to tighten the wedge in the tile spacer, taking care not to exceed the spacer's breaking point. Before proceeding to use the self-levelling tile spacer system, check that it does not damage the surface of the tiles, particularly in the case of rectified tiles or ones with a relief texture.

In accordance with the UNE EN 13888 standard, suitable grouting material must be used for the type of joint and the conditions of the tiled surface. To help you choose the right grout, we distinguish between indoor and outdoor tile-laying applications.

In the following table, the right type of grout for each situation is shown:

	INDOOR FLOORS	OUTDOOR FLOORS	INDOOR WALLS	FAÇADES
TILE JOINT	CG2	CG2 RG for contact with food, sanitary use, or contact with strong chemicals	CG1, CG2, RG in wet areas	CG2
PERIMETE JOINT	Minimum CG2	Minimum CG2 RG for contact with food, sanitary use, or contact with strong chemicals	Minimum CG2	Minimum CG2
PARTITION JOINT	Minimum CG2	Minimum CG2 RG for contact with food, sanitary use, or contact with strong chemicals	Minimum CG2	Minimum CG2
STRUCTURAL JOINT	Minimum CG2	Minimum CG2 RG for contact with food, sanitary use, or contact with strong chemicals	Minimum CG2	Minimum CG2

CG1- Normal cementitious grout
CG2 - Improved cementitious grout
RG - Synthetic resin (generally epoxy)

- In the case of floor surfaces, grout the tiles 48 hours after the tiles have been laid. In the case of wall surfaces, wait for 24 hours before grouting the tiles. Before proceeding to grout the tiles, make sure that the tile joints are absolutely clean.
- Remove any surplus grouting material immediately using a damp cloth. Do not let the surplus grout dry in case it hardens and becomes difficult to remove.
- Once the tiles have been laid, until all the building work is finished, protect the tile surface to prevent it from getting damaged.

RECOMENDACIONES MANIPULACIÓN

- La manipulación de las baldosas cerámicas debe realizarse con guantes de protección, y siempre prestando atención y con la máxima seguridad para evitar caídas o roturas.
- Para piezas de gran tamaño, se recomienda su manipulación y/o trasladado de una a una y por dos operarios, como mínimo. La extracción de las piezas de su embalaje se puede realizar manualmente o mediante algún sistema regulado por ventosas (si se realiza mediante este último, humedecerlas con anterioridad, y siguiendo instrucciones del fabricante).
- Se recomienda trasladar la baldosa de forma vertical para evitar la flexión de las piezas por su parte central.
- Para preservar la pieza, no apoyarla directamente ni sobre el suelo ni sobre la pared, apoyarla sobre soportes de corcho o cualquier otro material que resista su peso.
- Al tratarse de un material rectificado, tanto su manipulación como colocación debe de realizarse cuidadosamente, evitando los golpes entre piezas que puedan dañar las aristas.

RECOMENDACIONES CORTE Y PERFORACIONES

- Se recomienda realizar las operaciones de corte y/o perforación en espacios ventilados. Utilizar mascarillas y gafas de seguridad.
- Para evitar problemas con el microporo superficial, aconsejamos no marcar con lápiz ni con rotulador la superficie de las baldosas.
- Para garantizar un perfecto corte o perforación, situar la baldosa sobre una superficie perfectamente nivelada, plana y estable. Asegurarse de que se encuentra perfectamente apoyada.
- Para las operaciones de corte se recomienda el uso de equipos de corte de disco diamantado refrigerado por agua. Durante la operación de corte orientar el caudal directamente hacia el corte.
- Para las operaciones de perforación, en primer lugar y, para minimizar la posible rotura del material, se aconseja realizar un orificio en cada uno de los vértices del trazado que se quiere cortar mediante un taladro sin percusión. Utilizar brocas hasta de 8mm de diámetro. Humedecer antes la baldosa y la punta del taladro o bien utilizar brocas refrigeradas por agua. Posteriormente, proceder a cortar con una máquina radial de baja potencia equipada con un disco de diamante continuo.

RECOMENDACIONES COLOCACIÓN, JUNTAS Y MATERIAL DE AGARRE

- Antes de proceder a la instalación de las baldosas recomendamos extender varias piezas, ocupando una superficie de al menos 9 m², para ver cuál sería el efecto estético final. También es importante recordar que se deben coger piezas de varias cajas, para ver mejor el efecto de la variedad gráfica.
- Los productos MUSEUM la servimos protegidos con una cera especial para su manipulación al colocarlo. Dicha cera se elimina fácilmente con un paño humedecido con agua. Si no es posible su eliminación, utilizar un paño con alcohol de quemar.
- Asegurarse de que el soporte o superficie se encuentre perfectamente limpia para favorecer el agarre o la adhesión de la baldosa y perfectamente nivelada.
- Respecto a las juntas mínimas, en la siguiente tabla se muestran los tamaños recomendados en función del uso:

	PAVIMENTO INTERIOR	PAVIMENTO EXTERIOR	REVESTIMIENTO INTERIOR	FACHADAS
JUNTA DE COLOCACIÓN	>0,5 mm >2 mm para grandes formatos	>0,5 mm >2 mm para grandes formatos	>1,5 mm	>2,5 mm
JUNTA PERIMETRAL	>5 mm	>5 mm	>5 mm	>5 mm
JUNTA DE PARTICIÓN	>5 mm	>5 mm	>5 mm	8-10 mm
JUNTA ESTRUCTURAL	La misma que la junta estructural de soporte	La misma que la junta estructural de soporte, incluyendo cordón de poliuretano o perfil de compensación	La misma que la junta estructural de soporte	La misma que la junta estructural de soporte, incluyendo cordón de poliuretano o perfil de compensación de 6 a 35 mm

Find out the specific recommendations about 100x275 slabs handling:
Conozca las recomendaciones para manipular placas 100x275 cm:



Cabe destacar, que en el caso de MUSEUM, dado que todos los productos son rectificadas, se recomienda una junta mínima de colocación entre baldosas de 0.5 mm. Si son de gran formato, se recomienda de 2 mm.

- Se recomienda el uso de material de agarre, como mínimo tipo C2. Para grandes formatos, además, se aconseja que sea flexible. Respetar las recomendaciones del fabricante en la preparación y utilización tanto del material de agarre como material de rejunte.
- Se recomienda la colocación en capa fina con llana dentada, salvo para los grandes formatos que se recomienda el sistema en capa fina con doble encolado que consiste en la aplicación de una capa del material de agarre en la superficie o soporte y también en el reverso de la baldosa a instalar. Es muy importante, independientemente de la técnica utilizada, distribuir el material de agarre o cemento cola uniformemente por toda la superficie.
- Para asegurar el encolado completo de la baldosa, golpear o presionar la superficie con un mazo de goma blanca, nunca de color negro o gris.
- Utilizar crucetas separadoras autonivelantes para evitar posibles desniveles de las baldosas, sobre todo en la colocación trabada y de grandes formatos. Apretar con la tenaza sin superar el punto de rotura de esta. Antes de utilizar el sistema de crucetas autonivelantes, se recomienda comprobar que no dañen la superficie de la baldosa cerámicas, sobres todo en baldosas con relieve o rectificadas.

Respecto al material de rejunte, y de acuerdo con la UNE EN 13888, se define que es indispensable adecuar el material de rejunte al tipo de junta y a las condiciones de la superficie. Para ello, dividimos entre uso interior y exterior.

Se presenta a continuación un cuadro en el que se detalla la tipología de rejunte a utilizar:

	PAVIMENTO INTERIOR	PAVIMENTO EXTERIOR	REVESTIMIENTO INTERIOR	FACHADAS
JUNTA DE COLOCACIÓN	CG2	CG2 RG para usos alimentarios, sanitarios y de agresividad química	CG1, CG2, RG en zonas húmedas	CG2
JUNTA PERIMETRAL	Mínimo CG2	Mínimo CG2 RG para usos alimentarios, sanitarios y de agresividad química	Mínimo CG2	Mínimo CG2
JUNTA DE PARTICIÓN	Mínimo CG2	Mínimo CG2 RG para usos alimentarios, sanitarios y de agresividad química	Mínimo CG2	Mínimo CG2
JUNTA ESTRUCTURAL	Mínimo CG2	Mínimo CG2 RG para usos alimentarios, sanitarios y de agresividad química	Mínimo CG2	Mínimo CG2

CG1 – Rejuntado cementoso normal
CG2 – Rejuntado cementoso mejorado
RG – Resina sintética (epoxi generalmente)

- En pavimentos, proceder al rejuntado de las baldosas 48 horas después de su instalación. En revestimientos, tras 24 horas. Antes del rejuntado asegurarse de que las juntas se encuentren perfectamente limpias.
- Retirar el material de rejunte sobrante inmediatamente con la ayuda de una esponja humedecida con agua. No dejar secar el material para evitar problemas de limpieza debidos al endurecimiento del material.
- Una vez finaliza la colocación del material y, mientras dura la obra, proteger la superficie de las piezas para evitar que se dañe la superficie.

cleaning limpieza

INSTANT REMOVAL OF FRESH GROUT RESIDUES

Once tiles have been grouted and given an initial clean with a moist sponge, it is possible to leave the surface absolutely spotless, with no grout haze.

By using INSTANT REMOVER (for cement-based grout) or EPOXY PRO (for epoxy grout) by FILA, pristine surfaces that comply with the UNE 138002 standard can be achieved, the same day that they are grouted.

Both INSTANT solutions are fast and foam-free, they don't need rinsing, and they don't discolour the joints.

They are very simple to use. Once the tiles have been grouted and given an initial clean with a moist sponge, spray INSTANT REMOVER (or EXPOXY PRO in the case of epoxy joints) onto the tiled surface and leave it to act for 1 to 2 minutes. Then wipe the surface with a moist sponge or soft cloth.

CLEANING NEWLY-LAID TILED SURFACES

After walls or floors have been tiled, it is important to give the surface a thorough clean to remove grout residues and building dirt. A slightly acidic product, such as FILADETERDEK, should be used which does not release toxic fumes, harm users, or damage the tiles or tile joints. In the case of tiles laid with an epoxy or resinous grout, the surface should be cleaned with a detergent specially for epoxy materials, such as FILACR10.

EVERYDAY CARE

Ordinary Cleaning:

To clean the floor well, use a neutral detergent with a strong cleaning power, like FILACLEANER, which is able to remove layers of organic dirt without leaving a cloudy film.

Extraordinary Cleaning:

To remove strongly incrustated layers of organic dirt, PS87 cleaner should be used to give the surface a thorough clean.

Dilute one part of the product in up to 10 parts of water, depending on how dirty the surface is, and leave it to act for 5 minutes. Then rub the patches of dirt with a brush, remove any dirt residues (preferably with a vacuum cleaner for liquids), and rinse the surface with plenty of water.

There are many other types of incrustated dirt. The following table shows the right product by FILA for each kind of dirt:

TYPE OF INCRUSTED DIRT	PRODUCT BY FILA
LIGHT ORGANIC EVERYDAY DIRT	CLEANER
HEAVY ORGANIC DIRT	PS87
FAT, GREASE, OIL, SOFT DRINKS, FOOD AND SAUCE	
RUBBER, TYRES	
INK, MARKER PEN, PLASTIC PAINT	
DETERGENT, SOAP OR WAX REMAINS	CR10
EPOXY GROUT RESIDUES	
CEMENTITIOUS GROUT RESIDUES, SALT PETER	DETERDEK-PHZERO
LIMESCALE	
METAL SCRATCHES	
RUST	DETERDEK-NORUST
GRAFFITI	NOPAINT STAR
ACRYLIC, ALKYD & NITROSYNTHETIC SPRAY PAINT	
GREEN PLANT STAINS, ALGAE, MOSS, LICHEN	ALGACID
OUTDOOR BLACK MOULD	
SILICON & GLUE RESIDUES	ZERO SIL
FOAM & POLYURETHANE RESIDUES	
MARKS MADE BY ADHESIVE TAPE OR SUCTION CUPS	
CANDLEWAX, TREE RESIN	FUGANET
DIRTY TILE JOINTS	

LIMPIEZA INSTANTANEA DE RESIDUOS FRESCOS DE COLOCACIÓN

Una vez rejuntado y justo después de la primera limpieza con esponja húmeda, es posible dejar el material ya completamente limpio, evitando el posterior "empañado".

Los productos de la marca FILA INSTANT REMOVER (para junta cementosa) y EPOXY PRO (para junta epoxi) permiten una colocación completa, impecable y conforme a la normativa UNE 138002 en el mismo día del rejuntado.

Las soluciones INSTANT son rápidas, no crean espuma, no necesitan aclarado y no decoloran las juntas.

El procedimiento a seguir es sencillo, una vez rejuntado el material y realizable la primera limpieza con esponja húmeda, se pulveriza INSTANT REMOVER (EXPOXI PRO en junta epoxi) sobre la superficie cerámica, y se deja actuar durante 1-2 minutos. Después de este tiempo, se pasa una esponja humedecida o paño suave.

LIMPIEZA DE FINAL DE OBRA

Después de la colocación es fundamental realizar una buena limpieza con el fin de eliminar residuos de junta y en general suciedad de la obra. Para esta operación recomendamos el empleo de un detergente de acción ligeramente ácida que no despidan humos tóxicos y respete las juntas, el material y el usuario, como FILADETERDEK. En el caso de material colocado con junta epoxi o en base resina, se aconseja realizar la limpieza final de obra con un limpiador específico de residuos epoxi, como FILACR10.

LIMPIEZA DE MANTENIMIENTO

Limpieza Ordinaria:

Para un buen mantenimiento del pavimento se aconseja el empleo de un detergente neutro y con alto poder limpiador como FILACLEANER que no deja residuos ni empañados, por lo que elimina las capas de suciedad orgánica.

Limpieza Extraordinaria:

Para eliminar capas de suciedad orgánica intensa y acumulada en el tiempo, se recomienda realizar una limpieza profunda con detergente PS87.

El procedimiento consiste en diluir una parte del producto en hasta 10 partes de agua, según el nivel de suciedad, y dejar actuar unos 5 minutos, frotar con cepillo, recoger residuos (ideal con un aspirador de líquidos), y aclarar con abundante agua. Existen otros muchos tipos de suciedad incrustada, en el siguiente esquema, se especifican los diferentes productos FILA recomendados, en función del tipo de suciedad a tratar.

TIPO DE SUCIEDAD INCRUSTADA	SOLUCIÓN FILA
SUCIEDAD ORGÁNICA LIGERA (DIARIA)	CLEANER
SUCIEDAD ORGÁNICA INTENSA	PS87
GRASA, ACEITE, REFRESCOS, COMIDAS Y SALSAS	
GOMA, NEUMÁTICOS	
TINTES, ROTULADOR, PINTURA PLÁSTICA	
RESIDUOS DE DETERGENTES, JABONES, Y CERAS	CR10
RESIDUOS JUNTA EPOXI	
RESIDUOS JUNTA CEMENTOSA, SALITRE	DETERDEK-PHZERO
RESIDUOS CALCÁREOS	
RAYAS DE METALES	
ÓXIDOS	DETERDEK-NORUST
PINTADAS DE GRAFITIS	NOPAINT STAR
SPAY ACRÍLICOS, ALQUÍDICOS, Y NITROSINTÉTICOS	
VERDÍN, ALGAS, MUSGOS, LÍQUENES	ALGACID
ENNEGRECIDOS EXTERIORES	
RESIDUOS DE SILICONA Y PEGAMENTOS	ZERO SIL
RESIDUOS ESPUMA Y POLIURETANO	
RESIDUOS CINTA ADHESIVA, CERCOS DE VENTOSAS	
CERA DE VELA, RESINA DE ÁRBOLES	FUGANET
SUCIEDAD EN LA JUNTA	



regulation normativa

According to the UNE-EN-14411 specifications standard, our products belong to the following groups:

- PORCELAIN TILES** Group BIa, dry-pressed tiles, with a rate of water absorption E≤0.5%.
- FLOOR TILES** Group BIIa, dry-pressed tiles, 3<E≤6%.
- WALL TILES** Group BIII, dry-pressed tiles, E>10%.

Test standards:

ISO 10545-2: Determination of dimensions.
Sets forth the methods for determining dimensional characteristics (length, width, thickness, straightness of sides, rectangularity and surface planarity).

ISO 10545-3: Determination of water absorption.
Water absorption is a measure of the greater or lesser rate of porosity of the tile body. The test determines the amount absorbed by pieces, after being submerged in boiling water for two hours. The rate of water absorption is expressed as a % with respect to the dry mass of pieces.

ISO 10545-4: Determination of bending strength.
A tile's bending strength is determined by applying a force on the middle of the top side of the piece. The force applied is increased until the tile breaks. Bending strength is expressed in N/mm².

ISO 10545-7: Determination of the surface abrasion resistance of glazed tiles.
The resistance of the glazed layer of tiles to abrasion is determined by applying a rotating abrasive load on the tile surface and visually inspecting pieces that have undergone testing against those that have not. Classification ranges from PEI 1 to 5.

In order to determine the suitability of ceramic floor tiles, their wear resistance must be known. This is influenced by not only the characteristics of tiles, but also by the place where they will be installed. The presence of abrasive materials (sand, gravel, etc.) and locations in areas with direct outdoor access are factors which shorten the lifespan of floor tiles.

Our floor tiles have been classified into five groups, which determine their resistance to abrasion and wear:

PEI 1: Floor tiles exposed to light traffic, on which soft-soled footwear is used, free from abrasive products Recommended in bedrooms and bathrooms in private homes, with no direct outside entry.

PEI 2: Floor tiles exposed to average to light traffic, on which soft-soled footwear is used.

Recommended for all rooms in single-family homes except kitchens, entranceways, stairways and terraces.

PEI 3: Floor tiles exposed to average traffic, on which normal footwear is used. Recommended for all rooms in private homes and hotels, except for common areas such as stairways, entrances, etc.

PEI 4: Floor tiles exposed to average to heavy traffic. Recommended for all types of single-family homes and multiunit dwellings, terraces, kitchens, business premises and offices. Not belonging to this group are all public places exposed to intense traffic such as tobacconists', news stands, bakeries, bar areas, public transport stations, etc.

PEI 5: Floor tiles adapted to highly intense traffic. Recommended in shopping centres, train/bus stations, airports, etc. w

ISO 10545-9: Determination of resistance to thermal shock.
Determination of the resistance to thermal shock by cycling complete sample tiles ten times between 15°C and 145°C.

EN-101: Surface hardness.
Surface hardness determines the capacity of resistance of the glazed surface to scratching. Tiles are classified on a scale of 1 to 10 based on the increasing hardness of the minerals used to scratch their surface. The MOHS hardness scale is as follows:

1 talc – 2 gypsum – 3 calcite – 4 fluorite – 5 apatite – 6 feldspar – 7 quartz – 8 topaz – 9 corundum – 10 diamond.

ISO 10545-11: Determination of crazing resistance.
Determination of the resistance to the formation of fissures in the glazed layer by subjecting whole tiles to steam at a pressure of 5 Kg/cm in an autoclave, after which a dye is applied to the glazed layer and tiles are examined to detect possible fissures.

ISO 10545-12: Frost resistance.
This establishes a method whereby whole tiles are soaked in water and then undergo 100 freezing-thaw cycles, between + 5°C and – 5°C.

DIN-51130: Determination of the critical slippage angle. Ramp
This method is called "sloping ramp method", too. The tiles to be test must be installed on a platform that you could adjust the high, taking a total room of 100 x 50 cm. Immediately after, a coat of oil is applied on the surface and on the soles of the technician, who will make the test. The technician walks on the platform, which will increase the angle from the horizontal gradually. Until, the slippery signs will be detected by the technician. As a result of this test, we get the maximum angle to permit a safe traffic on the tile:

Angle	Group
6°< a <10°	R9
10°< a <19°	R10
19°< a <27°	R11
27°< a <35°	R12
35°< a	R13

UNE-41901 EX: Determination of slip resistance rating. Pendulum
The equipment consists of a pendulum whose arm measures 510 mm., to which a 76x25 mm. rubber slider is attached. Pendulum height is adjusted so that the slider remains in contact with the surface for a run of 126 mm. +/- 1 mm. The sample is submerged in water for a minimum of 30 minutes prior to testing. Each tile is tested in two opposite directions (0° and 180°), with the tile surface being:

Rd	Class	
< 15	0	
15< Rd <35	1	1 foot
35< Rd <45	2	2 feet
>45	3	3 feet

ISO 10545-13: Determination of chemical resistance.
This test determines the chemical resistance of tiles to cleaning agents, swimming pool additives, acids and alkalis, except for hydrofluoric acid (HF) and its compounds.

The visual classification of high concentrated acids and alkalis can be HA/HB/HC; low concentrated acids and alkalis can be LA/LB/LC; and cleaning products and swimming pool salts can be A/B/C, according to the chemical resistance grading:

A – No visible effect
B – Noticeable appearance modification
C – Partial or complete loss of surface appearance.

ISO 10545-14: Determination of resistance to stains.
Determination of resistance to stains by maintaining the tile face in contact with different test solutions during 24 hours. Once such time has passed, tile surface is cleaned with different cleaning agents. Finally, tiles are examined in order to determine irreversible changes in aspect. The classification rate varies from 5 to 1. Number 5 is achieved when tiles can be easily cleaned and number 1 corresponds to those tiles, whose surface is almost impossible to be cleaned.

Classification according the radioactive level: Class A (norm GB 6566)

Según la norma de especificaciones UNE-EN-14411, nuestros productos pertenecen a los siguientes grupos:

- GRES PORCELÁNICO** grupo BIa, baldosas prensadas en seco, con una absorción de agua E≤0.5%.
- GRES** grupo BIIa, baldosas prensadas en seco, 3<E≤6%.
- REVESTIMIENTO** grupo BIII, baldosas en seco, E>10%.

Normas de ensayo:

ISO 10545-2: Determinación de las dimensiones.
Establece métodos para la determinación de las características dimensionales (longitud, anchura, grosor, rectitud de lados, ortogonalidad y planitud de superficie).

ISO 10545-3: Determinación de la absorción de agua.
La absorción de agua es una medida de la mayor o menor porosidad del soporte cerámico. El ensayo determina la cantidad de agua que absorben las piezas, sumergidas en agua a ebullición durante dos horas. Se expresa en % de agua absorbida respecto a la masa en seco de las piezas.

ISO 10545-4: Determinación de la resistencia a la flexión.
Se determina la resistencia a la flexión de una baldosa, aplicando una fuerza en el centro de la cara vista. La fuerza aplicada va en aumento hasta conseguir romper la baldosa. La resistencia a la flexión se expresa en N/mm².

ISO 10545-7: Determinación de la abrasión superficial de las baldosas esmaltadas.

Determinación de la resistencia a la abrasión del esmalte de las baldosas, por rotación de una carga abrasiva sobre la superficie y comparación visual de baldosas sometidas y no sometidas al ensayo. La clasificación varía de PEI 1 hasta 5.

Para el uso correcto de un pavimento cerámico, hay que conocer la resistencia al desgaste del mismo. La cual está influenciada, no sólo por sus características, sino también por el lugar donde se va a instalar. La presencia de materiales abrasivos (arena, gravilla, ...), así como los locales con acceso directo desde el exterior, son factores que acortan la duración del pavimento.

Nuestros pavimentos han sido clasificados en cinco grupos, que establecen su resistencia a la abrasión y al desgaste:

PEI 1: Pavimentos sometidos a tráfico ligero, donde se utiliza calzado suave y exento de productos abrasivos. Recomendado en dormitorios y cuartos de baño de viviendas privadas, sin contacto con el exterior.

PEI 2: Pavimentos sometidos a tráfico medio-ligero, donde se utiliza calzado suave. Recomendado en todas las viviendas unifamiliares con excepción de cocinas, entradas, escaleras y terrazas.

PEI 3: Pavimentos sometidos a tráfico medio, donde se utiliza calzado normal. Recomendado en todas las habitaciones de las viviendas privadas y de hoteles, a excepción de las zonas comunes, como escaleras, entradas, etc.

PEI 4: Pavimentos sometidos a tráfico medio-alto. Recomendado en todo tipo de viviendas colectivas y unifamiliares, terrazas, cocinas, despachos y oficinas. No pertenecen a este grupo todos los lugares públicos sometidos a tráfico intenso, como estancos, puestos de periódicos, panaderías, barras de bar, estaciones de transporte público, etc.

PEI 5: Pavimentos adaptados a tráfico muy intenso. Recomendado en centros comerciales, estaciones, aeropuertos, etc.

ISO 10545-9: Resistencia al choque térmico.
Determinación de la resistencia al choque térmico de una baldosa entera sometida a diez ciclos de variación de temperatura entre 15°C y 145°C .

EN-101: Dureza superficial.
La dureza superficial determina la capacidad de resistencia de la superficie del esmalte al rayado. Las baldosas se clasifican en una escala de 1 a 10 en función de la dureza creciente de los minerales utilizados para rayarla. La escala de dureza MOHS es la siguiente:

1 talco – 2 yeso – 3 calcita – 4 fluorita – 5 apatito – 6 feldespato – 7 cuarzo – 8 topacio – 9 corindón – 10 diamante.

ISO 10545-11: Determinación de la resistencia al cuarteo.
Determinación de la resistencia a la formación de fisuras del esmalte, sometiendo baldosas enteras al vapor, a la presión de 5 Kg/cm en un autoclave y después examinándolas en busca de fisuras tras la aplicación de un tinte en la cara esmaltada.

ISO 10545-12: Determinación de la resistencia a la helada.
Establece un método mediante el cual, se impregnan de agua las baldosas enteras y se someten posteriormente a 100 ciclos de congelación–deshielo, entre + 5°C y – 5°C.

DIN-51130: Determinación del ángulo crítico de deslizamiento. Rampa
Este método también se llama "método de la rampa inclinada". Sobre una plataforma, que se puede regular en altura, se colocan las baldosas a ensayar ocupando una superficie total de 100 cm x 50 cm. Seguidamente se aplica uniformemente una capa de aceite sobre dicha superficie y en las suelas de los zapatos del técnico que realizará el ensayo. La plataforma, sobre la que camina un técnico, incrementa progresivamente el ángulo respecto de la horizontal, hasta que detecta indicios de deslizamiento. Como resultado se obtiene el ángulo máximo que permite una circulación segura sobre el pavimento:

Ángulo	Grupo
6°< a <10°	R9
10°< a <19°	R10
19°< a <27°	R11
27°< a <35°	R12
35°< a	R13

UNE-41901 EX: Determinación del valor de la resistencia al deslizamiento. Péndulo

El equipo consiste en un péndulo de longitud de brazo 510 mm, que soporta un deslizador de caucho de dimensiones 76x25 mm. La altura del equipo se ajusta para conseguir que el deslizador, mantenga el contacto con la superficie durante un recorrido de 126+1 mm. La muestra se sumerge en agua durante un mínimo de 30 minutos previamente al ensayo. Cada baldosa se ensaya en dos direcciones opuestas (0° y 180°) estando su superficie saturada de agua destilada.

Rd	Clase	
< 15	0	
15< Rd <35	1	1 zapato
35< Rd <45	2	2 zapatos
>45	3	3 zapatos

ISO 10545-13: Determinación de la resistencia química.
Dicho ensayo determina, por separado, la resistencia química de las baldosas, a los agentes de limpieza, sales de piscina, ácidos y álcalis. Con la exclusión del ácido fluorhídrico (HF) y sus compuestos. La clasificación visual para ácidos y álcalis de concentración fuerte varía desde HA, HB y HC; para ácidos y bases de concentración débil desde LA, LB y LC; y para productos de limpieza y sales de piscina entre A, B y C, en función de la resistencia química:

A – Sin efecto visible,
B – Clara modificación del aspecto,
C – Pérdida parcial o completa del aspecto de la superficie original.

ISO 10545-14: Determinación de la resistencia a las manchas.
Determinación de la resistencia a la mancha, manteniendo la cara vista en contacto con diversas soluciones de ensayo, durante 24 horas. Transcurridas las mismas, se limpia la superficie de las baldosas con diferentes agentes de limpieza. Y finalmente, se examinan para detectar cambios irreversibles de aspecto. La clasificación varía de 5 a 1. Siendo el 5, cuando las baldosas se limpian fácilmente y el 1, cuando es imposible limpiar la superficie.

Clasificación según el nivel de radioactividad: Clase A (norma GB 6566)





technical characteristics

características técnicas

circular economy







economía circular

TECHNICAL FEATURES ASPECTOS TÉCNICOS

								
	JOINT	FROST PROOF	VERSATILE	RECTIFIED	DIFFERENT SHADES	SHADE VARIATION V1 V2 V3 V4	VARIOUS GRAPHICS	CLEANING NON-ABRASIVE
Premium Polished (P)	•	•	•	•	•	•	•	•
Polished (EP)	•	•	•	•	•	•	•	•
Shaped (SP)	•	•	•	•	•	•	•	•
Natural (NT)	•	•	•	•	•	•	•	•
All in One (AS)	•	•	•	•	•	•	•	•
Antislip (A)	•	•	•	•	•	•	•	•

* Only Porcelain tiles, never White Body wall tiles.
* Sólo Porcelánico, nunca revestimiento de Pasta Blanca.

APPLICATIONS APLICACIONES

	Wall						Floor					
	P	EP	SP	NT	AS	A	P	EP	SP	NT	AS	A
INTERIOR	•	•	•	•	•	•	•	•	•	•	•	•
EXTERIOR	•	•	•	•	•	•	•	•	•	•	•	•
WET AREAS	•	•	•	•	•	•				•	•	•
TRAFFIC												

** Suitable for wet interior areas such as entrances to buildings from outer space (except in the case of direct access to restricted areas), covered terraces, changing rooms, showers, bathrooms, toilets, kitchens, etc.
** Adecuado para áreas interiores húmedas, como entradas a edificios desde el espacio exterior (excepto en el caso de acceso directo a áreas restringidas), terrazas cubiertas, vestuarios, duchas, baños, aseos, cocinas, etc.

*** Except MAINSTONE collection, that is for medium-high traffic.
*** Excepto la colección MAINSTONE, que es para tráfico medio-alto.

**** Except 4D TECH's SHAPED finish, that is for low traffic.
**** Excepto el acabado SHAPED de 4D TECH, que es para tráfico ligero.

All the collections in the MUSEUM range are ISO 14021 certified. This attests to the minimum amount of recycled content in each model, helping to achieve more sustainable and environmentally friendly products.

Todas las colecciones de la serie MUSEUM tienen la certificación ISO 14021, que acredita el porcentaje mínimo de material reciclado presente en cada una de ellas, logrando obtener productos más sostenibles y respetuosos con el medio que nos rodea.

FORMAT FORMATO	MINIMUM RECYCLED % % MÍNIMO RECICLADO			
	Porcelain 4D Porcelánico 4D	Porcelain Porcelánico	White Body 4D Pasta Blanca 4D	White Body Pasta Blanca
100X180 (P)	36			
100X180 (SP)	35			
100X180 (NT)	35			
100X100 (P)	36			
100X100 (SP)	35			
100X100 (NT)	35			
100X100X2 (A)	36			
50X100X2 (A)	36			
50X150 (SP)			54	
24X151		42		
75,5X151		42		
60X120		42		
90X90		42		
33,3X100X1,05				50
33,3X100X1,35				50

alphabetical index

índice alfabético

Item Artículo	Ref.	Price Tarifa	Size Formato (cm.)	Size Formato (in.)	Page Pág.
A ARTE CLOUD /75,5X151/EP	34695	M-58	75,5X151	29,7x59,5	37
ARTE CLOUD AS/60X120/C/R	34689	M-91	60X120	23,6x47,2	37
ARTE CLOUD AS/75,5X151/C/R	34692	M-92	75,5X151	29,7x59,5	37
ARTE CLOUD DECOR SP/50X150/R	34699	M-106	50X150	19,7x59,4	37
ARTE CLOUD SP/100X100/R	34702	M-93	100X100	39,4x39,4	37
ARTE CLOUD SP/100X180/R	34710	M-94	100X180	39,4x70,9	37
ARTE CLOUD SP/100X275/R	34683	M-90	100X275	39,4x108,3	37
ARTE CLOUD SP/50X150/R	34698	M-105	50X150	19,7x59,4	37
ARTE CLOUD/100X100X2/A/R	34705	M-113	100X100	39,4x39,4	37
ARTE CLOUD/50X100/A/R	35564	M-115	50X150	19,7x59,4	37
ARTE DESERT AS/60X120/C/R	34688	M-91	60X120	23,6x47,2	37
ARTE DESERT AS/75,5X151/C/R	34691	M-92	75,5X151	29,7x59,5	37
ARTE DESERT DECOR SP/50X150/R	34701	M-106	50X150	19,7x59,4	37
ARTE DESERT SP/100X100/R	34703	M-93	100X100	39,4x39,4	37
ARTE DESERT SP/100X180/R	34712	M-94	100X180	39,4x70,9	37
ARTE DESERT SP/100X275/R	34682	M-90	100X275	39,4x108,3	37
ARTE DESERT SP/50X150/R	34700	M-105	50X150	19,7x59,4	37
ARTE DESERT/100X100X2/A/R	34706	M-113	100X100	39,4x39,4	37
ARTE DESERT/50X100/A/R	35566	M-115	50X150	19,7x59,4	37
ARTE DESERT/75,5X151/EP	34694	M-58	75,5X151	29,7x59,5	37
ARTE MOCHA AS/60X120/C/R	34690	M-91	60X120	23,6x47,2	37
ARTE MOCHA AS/75,5X151/C/R	34693	M-92	75,5X151	29,7x59,5	37
ARTE MOCHA SP/100X100/R	34704	M-93	100X100	39,4x39,4	37
ARTE MOCHA SP/100X180/R	34711	M-94	100X180	39,4x70,9	37
ARTE MOCHA SP/100X275/R	34684	M-90	100X275	39,4x108,3	37
ARTE MOCHA/100X100X2/A/R	34707	M-113	100X100	39,4x39,4	37
ARTE MOCHA/50X100/A/R	35565	M-115	50X150	19,7x59,4	37
ARTE MOCHA/75,5X151/EP	34696	M-58	75,5X151	29,7x59,5	37
B BM CALACATTA EXTRA GOLD A NT/100X275/6	28448	M-100	100X275	40x109	47
BM CALACATTA EXTRA GOLD A/100X275/P	27943	M-88	100X275	40x109	47
BM CALACATTA EXTRA GOLD A/EP/75,5X151/6	34708	M-74	75,5X151	29,7x59,5	47
BM CALACATTA EXTRA GOLD B NT/100X275/6	28449	M-100	100X275	40x109	47
BM CALACATTA EXTRA GOLD B/100X275/P	27944	M-88	100X275	40x109	47
BM CALACATTA EXTRA GOLD B/EP/75,5X151/6	34709	M-74	75,5X151	29,7x59,5	47
BM CALACATTA EXTRA WHITE A NT/100X275/6	29370	M-100	100X275	40x109	47
BM CALACATTA EXTRA WHITE A/100X275/P	27852	M-88	100X275	40x109	47
BM CALACATTA EXTRA WHITE B NT/100X275/6	29371	M-100	100X275	40x109	47
BM CALACATTA EXTRA WHITE B/100X275/P	27853	M-88	100X275	40x109	47
C CALACATTA EXTRA GOLD NT/100X275/R	36867	M-95	100X275	40x109	47
CALACATTA EXTRA GOLD/100X275/P	36868	M-87	100X275	40x109	47
CALACATTA EXTRA WHITE NT/100X100/C/R	23977	M-69	100X100	39,4x39,4	47
CALACATTA EXTRA WHITE NT/100X180/C/R	23211	M-75	100X180	39,4x70,9	47
CALACATTA EXTRA WHITE NT/100X275/R	36871	M-95	100X275	40x109	47
CALACATTA EXTRA WHITE/100X100/P	24206	M-70	100X100	39,4x39,4	47
CALACATTA EXTRA WHITE/100X180/P	24203	M-76	100X180	39,4x70,9	47
CALACATTA EXTRA WHITE/100X275/P	36874	M-87	100X275	40x109	47
CHICAGO CLOUD A/0X100/R	36389	M-113	100X100	39,4x39,4	63
CHICAGO CLOUD A/50X150/R	36803	M-115	50X100	20x40	63
CHICAGO CLOUD DECOR SP/50X150/R	31971	M-106	50X150	19,7x59,4	63
CHICAGO CLOUD NT/60X120/R	31767	M-101	60X120	23,6x47,2	63
CHICAGO CLOUD NT/90X90/R	31883	M-102	90X90	35,4x35,4	63
CHICAGO CLOUD SP/100X100/R	31824	M-93	100X100	39,4x39,4	63
CHICAGO CLOUD SP/100X180/R	31758	M-94	100X180	39,4x70,9	63
CHICAGO CLOUD SP/100X275/R	35936	M-90	100X275	40x109	63
CHICAGO CLOUD SP/50X150/R	31967	M-105	50X150	19,7x59,4	63
CHICAGO CLOUD/90X90/A/C/R	31887	M-81	90X90	35,4x35,4	63
CHICAGO MOCHA A/100X100/R	36390	M-113	100X100	39,4x39,4	63
CHICAGO MOCHA A/50X100/R	36804	M-115	50X100	20x40	63
CHICAGO MOCHA DECOR SP/50X150/R	31972	M-106	50X150	19,7x59,4	63
CHICAGO MOCHA NT/60X120/R	31821	M-101	60X120	23,6x47,2	63
CHICAGO MOCHA NT/90X90/R	31884	M-102	90X90	35,4x35,4	63
CHICAGO MOCHA SP/100X100/R	31825	M-93	100X100	39,4x39,4	63
CHICAGO MOCHA SP/100X180/R	31820	M-94	100X180	39,4x70,9	63

Item Artículo	Ref.	Price Tarifa	Size Formato (cm.)	Size Formato (in.)	Page Pág.
CHICAGO MOCHA SP/100X275/R	36619	M-90	100X275	40x109	63
CHICAGO MOCHA SP/50X150/R	31968	M-105	50X150	19,7x59,4	63
CHICAGO MOCHA/90X90/A/C/R	31889	M-81	90X90	35,4x35,4	63
CHICAGO MOON A/100X100/R	36391	M-113	100X100	39,4x39,4	63
CHICAGO MOON A/50X100/R	36805	M-115	50X100	20x40	63
CHICAGO MOON DECOR SP/50X150/R	31973	M-106	50X150	19,7x59,4	63
CHICAGO MOON NT/60X120/R	31768	M-101	60X120	23,6x47,2	63
CHICAGO MOON NT/90X90/R	31885	M-102	90X90	35,4x35,4	63
CHICAGO MOON SP/100X100/R	31826	M-93	100X100	39,4x39,4	63
CHICAGO MOON SP/100X180/R	31760	M-94	100X180	39,4x70,9	63
CHICAGO MOON SP/100X275/R	35922	M-90	100X275	40x109	63
CHICAGO MOON SP/50X150/R	31970	M-105	50X150	19,7x59,4	63
CHICAGO MOON/90X90/A/C/R	31890	M-81	90X90	35,4x35,4	63
CHICAGO ROAD A/100X100/R	36392	M-113	100X100	39,4x39,4	63
CHICAGO ROAD A/50X100/R	36806	M-115	50X100	20x40	63
CHICAGO ROAD DECOR SP/50X150/R	31974	M-106	50X150	19,7x59,4	63
CHICAGO ROAD NT/60X120/R	31769	M-101	60X120	23,6x47,2	63
CHICAGO ROAD NT/90X90/R	31886	M-102	90X90	35,4x35,4	63
CHICAGO ROAD SP/100X100/R	31827	M-93	100X100	39,4x39,4	63
CHICAGO ROAD SP/100X180/R	31759	M-94	100X180	39,4x70,9	63
CHICAGO ROAD SP/100X275/R	36618	M-90	100X275	40x109	63
CHICAGO ROAD SP/50X150/R	31969	M-105	50X150	19,7x59,4	63
CHICAGO ROAD/90X90/A/C/R	31888	M-81	90X90	35,4x35,4	63
CRYSTAL THUNDER/60X120/EP	28562	M-40	60X120	23,6x47,2	75
CRYSTAL THUNDER/75,5X151/EP	28564	M-58	75,5X151	29,7x59,5	75
CRYSTAL WHITE/60X120/EP	28561	M-40	60X120	23,6x47,2	75
CRYSTAL WHITE/75,5X151/EP	28563	M-58	75,5X151	29,7x59,5	75
D D.ARTE CLOUD AS MOSAIC/16T/30X30	34885	U36	30X30	11,8x11,8	38
D.ARTE CLOUD GEO SP/25X25	34883	U58	25X25	9,8x9,8	38
D.ARTE CLOUD HORIZON/30X60	34896	U66	30X60	11,8x23,6	38
D.ARTE CLOUD/DESERT/MOCHA MIX/30X30	34888	U51	30X30	11,8x11,8	38
D.ARTE DESERT AS MOSAIC/16T/30X30	34886	U36	30X30	11,8x11,8	38
D.ARTE DESERT GEO SP/25X25	34884	U58	25X25	9,8x9,8	38
D.ARTE DESERT HORIZON/30X60	34902	U66	30X60	11,8x23,6	38
D.ARTE MOCHA AS MOSAIC/16T/30X30	34887	U36	30X30	11,8x11,8	38
D.ARTE MOCHA HORIZON/30X60	34903	U66	30X60	11,8x23,6	38
D.CHICAGO CLOUD GEO SP/25X25	32195	U58	25X25	9,8x9,8	64
D.CHICAGO CLOUD NT MOSAIC/16T/30X30	32200	U36	30X30	11,8x11,8	64
D.CHICAGO M/DOLPHIN/HAUTE MIX SP/30X30	32073	U55	30X30	11,8x11,8	64
D.CHICAGO W/KALUA/MOCHA MIX SP/30X30	32072	U55	30X30	11,8x11,8	64
D.CHICAGO MOCHA GEO SP/25X25	32197	U58	25X25	9,8x9,8	64
D.CHICAGO MOCHA NT MOSAIC/16T/30X30	32202	U36	30X30	11,8x11,8	64
D.CHICAGO MOON GEO SP/25X25	32198	U58	25X25	9,8x9,8	64
D.CHICAGO MOON NT MOSAIC/16T/30X30	32203	U36	30X30	11,8x11,8	64
D.CHICAGO ROAD GEO SP/25X25	32196	U58	25X25	9,8x9,8	64
D.CHICAGO ROAD NT MOSAIC/16T/30X30	32201	U36	30X30	11,8x11,8	64
D.CRYSTAL MIX/30X30/EP	29172	U51	30X30	11,8x11,8	75
D.DREAMY CLOUD ARROW/30X30/AS	30371	U64	30X30	11,8x11,8	88
D.DREAMY CLOUD ARROW/30X30/EP	30375	U64	30X30	11,8x11,8	88
D.DREAMY CLOUD TRIANGLE/29X29/AS	35285	U58	29X29	11,4x11,4	88
D.DREAMY DESERT ARROW/30X30/AS	30372	U64	30X30	11,8x11,8	88
D.DREAMY DESERT ARROW/30X30/EP	30376	U64	30X30	11,8x11,8	88
D.DREAMY DESERT TRIANGLE/29X29/AS	35286	U58	29X29	11,4x11,4	88
D.DREAMY MOCHA ARROW/30X30/AS	30373	U64	30X30	11,8x11,8	88
D.DREAMY MOCHA ARROW/30X30/EP	30378	U64	30X30	11,8x11,8	88
D.DREAMY ROAD ARROW/30X30/AS	30374	U64	30X30	11,8x11,8	88
D.DREAMY ROAD ARROW/30X30/EP	30377	U64	30X30	11,8x11,8	88
D.DUAL TRIANGLE SP/29X29	32070	U53	29X29	11,4x11,4	102
D.DUAL WHITE/PORTO CHEVRON NT/30X21,9	32076	U55	30X21,9	11,8x8,6	102
D.DUAL WHITE/PORTO CHEVRON/30X21,9/EP	32077	U55	30X21,9	11,8x8,6	102
D.DUAL/KALUA/MOCHA MIX NT/30X30	32072	U55	30X30	11,8x11,8	102
D.GROW DOLPHIN ARR 1/SP/9,6X44,9	31178	U51	9,6X44,9	5,9x13,6	118
D.GROW DOLPHIN ARR 2/SP/9,6X44,9	31179	U51	9,6X44,9	5,9x13,6	118

Item Artículo	Ref.	Price Tarifa	Size Formato (cm.)	Size Formato (in.)	Page Pág.
D.GROW DOLPHIN TANGRAM SP/30X30	31171	U53	30X30	11,8x11,8	118
D.GROW DOLPHIN TRIANGLE SP/29X29	31296	U58	29X29	11,4x11,4	118
D.GROW HONEY ARR 1/SP/9,6X44,9	31180	U51	9,6X44,9	5,9x13,6	118
D.GROW HONEY ARR 2/SP/9,6X44,9	31201	U51	9,6X44,9	5,9x13,6	118
D.GROW HONEY TANGRAM SP/30X30	31172	U53	30X30	11,8x11,8	118
D.GROW HONEY TRIANGLE SP/29X29	31297	U58	29X29	11,4x11,4	118
D.GROW KALUA ARR 1/SP/9,6X44,9	31303	U51	9,6X44,9	5,9x13,6	118
D.GROW KALUA ARR 2/SP/9,6X44,9	31304	U51	9,6X44,9	5,9x13,6	118
D.GROW KALUA TANGRAM SP/30X30	31306	U53	30X30	11,8x11,8	118
D.GROW KALUA TRIANGLE/29X29	31298	U58	29X29	11,4x11,4	118
D.GROW MAPLE ARR 1/SP/9,6X44,9	31181	U51	9,6X44,9	5,9x13,6	118
D.GROW MAPLE ARR 2/SP/9,6X44,9	31202	U51	9,6X44,9	5,9x13,6	118
D.GROW MAPLE TANGRAM SP/30X30	31173	U53	30X30	11,8x11,8	118
D.GROW MAPLE TRIANGLE/29X29	31299	U58	29X29	11,4x11,4	118
D.GROW PORTO ARR 1/SP/9,6X44,9	31182	U51	9,6X44,9	5,9x13,6	118
D.GROW PORTO ARR 2/SP/9,6X44,9	31204	U51	9,6X44,9	5,9x13,6	118
D.GROW PORTO TANGRAM SP/30X30	31174	U53	30X30	11,8x11,8	118
D.GROW PORTO TRIANGLE/29X29	31300	U58	29X29	11,4x11,4	118
D.GROW TAUPE ARR 1/SP/9,6X44,9	31183	U51	9,6X44,9	5,9x13,6	118
D.GROW TAUPE ARR 2/SP/9,6X44,9	31203	U51	9,6X44,9	5,9x13,6	118
D.GROW TAUPE TANGRAM SP/30X30	31175	U53	30X30	11,8x11,8	118
D.GROW TAUPE TRIANGLE/29X29	31301	U58	29X29	11,4x11,4	118
D.GROW WHITE ARR 1/SP/9,6X44,9	31184	U51	9,6X44,9	5,9x13,6	118
D.GROW WHITE ARR 2/SP/9,6X44,9	31205	U51	9,6X44,9	5,9x13,6	118
D.GROW WHITE TANGRAM SP/30X30	31176	U53	30X30	11,8x11,8	118
D.GROW WHITE TRIANGLE SP/29X29	31302	U58	29X29	11,4x11,4	118
D.HAUTE WHITE TRIANGLE SP/29X29	31149	U55	29X29	11,4x11,4	132
D.HAUTE WHITE/DOLPHIN MIX/30X30	31148	U51	30X30	11,8x11,8	132
D.HAUTE WHITE/KALUA CHEVRON SP/30X21,9	31155	U51	30X21,9	11,8x8,6	132
D.HAUTE WHITE/KALUA CHEVRON/30X21,9/EP	31152	U51	30X21,9	11,8x8,6	132
D.HAUTE WHITE/TAUPE CHEVRON SP/30X21,9	31154	U51	30X21,9	11,8x8,6	132
D.HAUTE WHITE/TAUPE CHEVRON/30X21,9/EP	31151	U51	30X21,9	11,8x8,6	132
D.IRON DENIM SP/30X50	29168	U64	30X50		

alphabetical index

índice alfabético

Item Articulo	Ref.	Price Tarifa	Size Formato (cm.)	Size Formato (in.)	Page Pág.
HAUTE WHITE/60X120/EP	30996	M-40	60X120	23,6x47,2	131
HAUTE WHITE/75,5X151/EP	31000	M-58	75,5X151	29,7x59,5	131
I IRON DENIM SP/100X100/R	28725	M-93	100X100	39,4x39,4	141
IRON DENIM SP/100X180/R	28724	M-94	100X180	39,4x70,9	141
IRON OXIDE SP/100X100/R	28726	M-93	100X100	39,4x39,4	141
IRON OXIDE SP/100X180/R	28723	M-94	100X180	39,4x70,9	141
K KRON CHARCOAL NT/100X275/R	36127	M-89	100X275	40x109	149
KRON GRAY NT/100X275/R	36879	M-89	100X275	40x109	149
L LAKESTONE CLOUD AS/60X120/C/R	28543	M-91	60X120	23,6x47,2	159
LAKESTONE CLOUD AS/90X90/C/R	28546	M-81	90X90	35,4x35,4	159
LAKESTONE CLOUD DECOR/33,3X100/R	28573	M-83	33,3X100	13,1x39,4	159
LAKESTONE CLOUD NT/33,3X100/R	28574	M-82	33,3X100	13,1x39,4	159
LAKESTONE DOLPHIN AS/60X120/C/R	28545	M-91	60X120	23,6x47,2	159
LAKESTONE DOLPHIN AS/90X90/C/R	28548	M-81	90X90	35,4x35,4	159
LAKESTONE OAT AS/60X120/C/R	28544	M-91	60X120	23,6x47,2	159
LAKESTONE OAT AS/90X90/C/R	28547	M-81	90X90	35,4x35,4	159
LUMINA ICE/60X120/EP	25703	M-40	60X120	23,6x47,2	169
LUMINA ICE/75,5X151/EP	25579	M-58	75,5X151	29,7x59,5	169
M MAINSTONE CLOUD NT/60X120/C/R	27250	M-66	60X120	23,6x47,2	179
MAINSTONE CLOUD NT/75,5X151/C/R	27835	M-59	75,5X151	29,7x59,5	179
MAINSTONE CLOUD NT/90X90/C/R	27258	M-68	90X90	35,4x35,4	179
MAINSTONE CLOUD/90X90/A/R	27819	M-81	90X90	35,4x35,4	179
MAINSTONE DOLPHIN NT/60X120/C/R	27249	M-66	60X120	23,6x47,2	179
MAINSTONE DOLPHIN NT/75,5X151/C/R	27836	M-59	75,5X151	29,7x59,5	179
MAINSTONE DOLPHIN NT/90X90/C/R	27259	M-68	90X90	35,4x35,4	179
MAINSTONE DOLPHIN/90X90/A/R	27828	M-81	90X90	35,4x35,4	179
MAINSTONE MOON NT/60X120/C/R	27248	M-66	60X120	23,6x47,2	179
MAINSTONE MOON NT/75,5X151/C/R	27837	M-59	75,5X151	29,7x59,5	179
MAINSTONE MOON NT/90X90/C/R	27256	M-68	90X90	35,4x35,4	179
MAINSTONE MOON/90X90/A/R	27830	M-81	90X90	35,4x35,4	179
MAINSTONE OAT NT/60X120/C/R	27251	M-66	60X120	23,6x47,2	179
MAINSTONE OAT NT/75,5X151/C/R	27838	M-59	75,5X151	29,7x59,5	179
MAINSTONE OAT NT/90X90/C/R	27257	M-68	90X90	35,4x35,4	179
MAINSTONE OAT/90X90/A/R	27829	M-81	90X90	35,4x35,4	179
MARQUINA BLACK/60X120/EP	23461	M-73	60X120	23,6x47,2	189
MARQUINA BLACK/75,5X151/EP	23453	M-74	75,5X151	29,7x59,5	189
O ONIX PEARL/60X120/EP	22110	M-40	60X120	23,6x47,2	197
ONIX PEARL/75,5X151/EP	21069	M-58	75,5X151	29,7x59,5	197
OPERA FUMO/60X120/EP	25964	M-73	60X120	23,6x47,2	205
OPERA FUMO/75,5X151/EP	25971	M-74	75,5X151	29,7x59,5	205
OROBICO DARK/60X120/EP	27335	M-73	60X120	23,6x47,2	213
OROBICO DARK/75,5X151/EP	27338	M-74	75,5X151	29,7x59,5	213
OROBICO LIGHT/60X120/EP	27336	M-73	60X120	23,6x47,2	213
OROBICO LIGHT/75,5X151/EP	27337	M-74	75,5X151	29,7x59,5	213
P PRALINE GOLD DECOR SP/33,3X100/R	34677	M-97	33,3X100	13,1x39,4	227
PRALINE GOLD SP/100X100/R	34673	M-93	100X100	39,4x39,4	227
PRALINE GOLD SP/100X180/R	34674	M-94	100X180	39,4x70,9	227
PRALINE GOLD SP/100X275/R	34681	M-100	100X275	40x108,3	227
PRALINE GOLD SP/33,3X100/R	34676	M-96	33,3X100	13,1x39,4	227
PRALINE GOLD NT/60X120/R	34669	M-101	60X120	23,6x47,2	227
PRALINE GOLD NT/75,5X151/R	34671	M-103	75,5X151	29,7x59,5	227
PRALINE GOLD/100X180/P	34675	M-76	100X180	39,4x70,9	227
PRALINE GOLD/60X120/EP	34670	M-40	60X120	23,6x47,2	227
PRALINE GOLD/75,5X151/EP	34672	M-58	75,5X151	29,7x59,5	227
PREMIERE WHITE SP/100X100/R	32931	M-93	100X100	39,4x39,4	239
PREMIERE WHITE SP/100X180/R	32932	M-94	100X180	39,4x70,9	239
PREMIERE WHITE SP/100X275/R	36118	M-100	100X275	40x109	239
PREMIERE WHITE SP/60X120/R	32929	M-101	60X120	23,6x47,2	239
PREMIERE WHITE SP/75,5X151/R	32930	M-103	75,5X151	29,7x59,5	239
PREMIERE WHITE/100X180/P	32933	M-76	100X180	39,4x70,9	239
PREMIERE WHITE/60X120/EP	32908	M-40	60X120	23,6x47,2	239
PREMIERE WHITE/75,5X151/EP	32934	M-58	75,5X151	29,7x59,5	239
S STATUARIO PLUS/60X120/EP	23462	M-40	60X120	23,6x47,2	247

Item Articulo	Ref.	Price Tarifa	Size Formato (cm.)	Size Formato (in.)	Page Pág.
STATUARIO PLUS/75,5X151/EP	23463	M-58	75,5X151	29,7x59,5	247
STROND CLOUD SP/100X100/R	31761	M-93	100X100	39,4x39,4	261
STROND CLOUD SP/100X180/R	32861	M-94	100X180	39,4x70,9	261
STROND CLOUD SP/100X275/R	36125	M-90	100X275	40x109	261
STROND CLOUD SP/60X120/R	32852	M-101	60X120	23,6x47,2	261
STROND CLOUD SP/90X90/R	32855	M-102	90X90	35,4x35,4	261
STROND CLOUD/100X100X2/A/R	32864	M-113	100X100	39,4x39,4	261
STROND CLOUD/90X90/A/R	32858	M-81	90X90	35,4x35,4	261
STROND CLOUD A/50X100/R	35571	M-115	50X100	20x40	261
STROND DOLPHIN SP/100X100/R	31764	M-93	100X100	39,4x39,4	261
STROND DOLPHIN SP/100X180/R	32862	M-94	100X180	39,4x70,9	261
STROND DOLPHIN SP/100X275/R	36878	M-90	100X275	40x109	261
STROND DOLPHIN SP/60X120/R	32853	M-101	60X120	23,6x47,2	261
STROND DOLPHIN SP/90X90/R	32857	M-102	90X90	35,4x35,4	261
STROND DOLPHIN/100X100X2/A/R	32865	M-113	100X100	39,4x39,4	261
STROND DOLPHIN A/50X100/R	35572	M-115	50X100	20x40	261
STROND DOLPHIN/90X90/A/R	32859	M-81	90X90	35,4x35,4	261
STROND OAT SP/100X100/R	31763	M-93	100X100	39,4x39,4	261
STROND OAT SP/100X180/R	32863	M-94	100X180	39,4x70,9	261
STROND OAT SP/100X260/R	36126	M-90	100X275	40x109	261
STROND OAT SP/60X120/R	32854	M-101	60X120	23,6x47,2	261
STROND OAT SP/90X90/R	32856	M-102	90X90	35,4x35,4	261
STROND OAT A/50X100/R	35573	M-115	50X100	20x40	261
STROND OAT/100X100X2/A/R	32866	M-113	100X100	39,4x39,4	261
STROND OAT/90X90/A/R	32860	M-81	90X90	35,4x35,4	261
SUBLIME CLIFF SP/100X100/R	36251	M-93	100X100	39,4x39,4	279
SUBLIME CLIFF SP/100X180/R	36256	M-94	100X180	39,4x70,9	279
SUBLIME CLIFF SP/100X275/R	36266	M-100	100X275	39,4x108,3	279
SUBLIME CLIFF/100X275/P	36270	M-87	100X275	39,4x108,3	279
SUBLIME ICEBERG DECOR SP/33,3X100/R	36261	M-97	33,3X100	13,1x39,4	279
SUBLIME ICEBERG NT/60X120/C/R	36193	M-101	60X120	23,6x47,2	279
SUBLIME ICEBERG NT/75,5X151/C/R	36161	M-103	75,5X151	29,7x59,5	279
SUBLIME ICEBERG SP/100X100/R	36142	M-93	100X100	39,4x39,4	279
SUBLIME ICEBERG SP/100X180/R	36141	M-94	100X180	39,4x70,9	279
SUBLIME ICEBERG SP/100X275/R	36262	M-100	100X275	39,4x108,3	279
SUBLIME ICEBERG SP/33,3X100/R	36263	M-96	33,3X100	13,1x39,4	279
SUBLIME ICEBERG/100X275/P	36267	M-87	100X275	39,4x108,3	279
SUBLIME ICEBERG/60X120/EP	36192	M-40	60X120	23,6x47,2	279
SUBLIME ICEBERG/75,5X151/EP	36190	M-58	75,5X151	29,7x59,5	279
SUBLIME THUNDER DECOR SP/33,3X100/R	36271	M-97	33,3X100	13,1x39,4	279
SUBLIME THUNDER NT/60X120/C/R	36236	M-101	60X120	23,6x47,2	279
SUBLIME THUNDER NT/75,5X151/C/R	36247	M-103	75,5X151	29,7x59,5	279
SUBLIME THUNDER SP/100X100/R	36250	M-93	100X100	39,4x39,4	279
SUBLIME THUNDER SP/100X180/R	36257	M-94	100X180	39,4x70,9	279
SUBLIME THUNDER SP/100X275/R	36264	M-95	100X275	39,4x108,3	279
SUBLIME THUNDER SP/33,3X100/R	36272	M-96	33,3X100	13,1x39,4	279
SUBLIME THUNDER/100X275/P	36268	M-87	100X275	39,4x108,3	279
SUBLIME THUNDER/60X120/EP	36239	M-40	60X120	23,6x47,2	279
SUBLIME THUNDER/75,5X151/EP	36243	M-58	75,5X151	29,7x59,5	279
SUBLIME VULCANO NT/60X120/C/R	36235	M-101	60X120	23,6x47,2	279
SUBLIME VULCANO NT/75,5X151/C/R	36248	M-103	75,5X151	29,7x59,5	279
SUBLIME VULCANO/100X275/P	36269	M-88	100X275	39,4x108,3	279
SUBLIME VULCANO/60X120/EP	36240	M-73	60X120	23,6x47,2	279
SUBLIME VULCANO/75,5X151/EP	36244	M-74	75,5X151	29,7x59,5	279
SUPREME WHITE NT/60X120/R	27328	M-66	60X120	23,6x47,2	293
SUPREME WHITE NT/75,5X151/R	27330	M-69	75,5X151	29,7x59,5	293
SUPREME WHITE SP/100X100/R	27511	M-93	100X100	39,4x39,4	293
SUPREME WHITE SP/100X180/R	27512	M-94	100X180	39,4x70,9	293
SUPREME WHITE SP/100X275/R	31845	M-100	100X275	40x109	293
SUPREME WHITE/100X180/P	27513	M-76	100X180	39,4x70,9	293
SUPREME WHITE/60X120/EP	27327	M-40	60X120	23,6x47,2	293
SUPREME WHITE/75,5X151/EP	27329	M-58	75,5X151	29,7x59,5	293
T TORANO BIANCO NT/90X90/R	25980	M-68	90X90	35,4x35,4	305

Item Articulo	Ref.	Price Tarifa	Size Formato (cm.)	Size Formato (in.)	Page Pág.
TORANO BIANCO/2/90X90/EP	25173	M-2	90X90	35,4x35,4	305
TORANO BIANCO/60X120/EP	22011	M-40	60X120	23,6x47,2	305
TORANO BIANCO/60X120/NAT/R	22012	M-66	60X120	23,6x47,2	305
TORANO BIANCO/75,5X151/EP	21070	M-58	75,5X151	29,7x59,5	305
TORANO BIANCO/75,5X151/NAT/R	21074	M-59	75,5X151	29,7x59,5	305
TORANO GOLD NT/60X120/R	27282	M-66	60X120	23,6x47,2	305
TORANO GOLD NT/75,5X151/R	27283	M-59	75,5X151	29,7x59,5	305
TORANO GOLD NT/90X90/R	27831	M-68	90X90	35,4x35,4	305
TORANO GOLD/60X120/EP	27275	M-40	60X120	23,6x47,2	305
TORANO GOLD/75,5X151/EP	27281	M-58	75,5X151	29,7x59,5	305
TORANO GOLD/90X90/EP	27832	M-2	90X90	35,4x35,4	305
TRAP.GROW DOLPHIN SP/14,7X34,1	31159	U34	14,7X34,1	5,8x13,4	118
TRAP.GROW HONEY SP/14,7X34,1	31160	U34	14,7X34,1	5,8x13,4	118
TRAP.GROW KAULA SP/14,7X34,1	31305	U34	14,7X34,1	5,8x13,4	118
TRAP.GROW MAPLE SP/14,7X34,1	31161	U34	14,7X34,1	5,8x13,4	118
TRAP.GROW PORTO SP/14,7X34,1	31162	U34	14,7X34,1	5,8x13,4	118
TRAP.GROW TAUPE SP/14,7X34,1	31163	U34	14,7X34,1	5,8x13,4	118
TRAP.GROW WHITE SP/14,7X34,1	31164	U34	14,7X34,1	5,8x13,4	118
TRAP.HAUTE WHITE SP/14,7X34,1	31146	U34	14,7X34,1	5,8x13,4	132
TRAP.HAUTE WHITE/14,7X34,1/EP	31147	U34	14,7X34,1	5,8x13,4	132
TRAP.MARQUINA BLACK/14,7X34,1/EP	23563	U28	14,7X34,1	5,8x13,4	189
TRAP.Opera FUMO/14,7X34,1/EP	26319	U28	14,7X34,1	5,8x13,4	205
TRAP.STATUARIO PLUS/14,7X34,1/EP	23564	U28	14,7X34,1	5,8x13,4	247
TRI.CRYSTAL THUNDER/29,9X25,7/EP	29170	U34	29,9X25,7	11,8x10,1	75
TRI.CRYSTAL WHITE/29,9X25,7/EP	29171	U34	29,9X25,7	11,8x10,1	75
TRI.MAINSTONE CLOUD NT/29,9X25,7/C	27847	U34	29,9X25,7	11,8x10,1	180
TRI.MAINSTONE DOLPHIN NT/29,9X25,7/C	27850	U34	29,9X25,7	11,8x10,1	180
TRI.MAINSTONE MOON NT/29,9X25,7/C	27851	U34	29,9X25,7	11,8x10,1	180
TRI.MAINSTONE OAT NT/29,9X25,7/C	27849	U34	29,9X25,7	11,8x10,1	180
TRI.MARQUINA BLACK/16,7X14,7/EP	23560	U13	16,7X14,7	6,6x5,8	189

MUSEUM

Once ceramic tiles reach the end of their useful life, they are inert waste. For their proper management, they should be given to an authorized waste management body for recycling purposes.

All colours and hues appearing in this catalogue should be considered approximate, only in view of the printing processes involved. The rights of all contents (texts, photographs, drawings, designs, etc.) of this catalogue remain the property of PERONDA GROUP S.A. (or, failing that, they have the corresponding permissions of the owners). No part of this publication may be reproduced, stored in a retrieval system, or transmitted in any form or by any means, electronic, mechanical, photocopying, recording or otherwise, without the prior written permission of the copyright holders.

Paper made from fibers from responsibly managed forest.

Las baldosas cerámicas una vez que llegan al final de su vida útil son un residuo inerte, que para su correcta gestión debe ser entregado a un gestor autorizado de residuos, favoreciendo su reciclado.

Debido a los procesos de impresión, los colores que aparecen en este catálogo deben considerarse aproximados, y no exactos. Los derechos de todos los contenidos (textos, fotografías, dibujos, diseños etc) del presente catálogo son propiedad de PERONDA GROUP, S.A. (o en su defecto, cuentan con los correspondientes permisos y autorizaciones de sus titulares). No está permitida la reproducción total o parcial de esta publicación, ni su tratamiento informático, ni la transmisión de ninguna forma o por cualquier medio, ya sea electrónico, mecánico, por fotocopia, por registro u otros medios, sin el permiso previo y por escrito de los titulares del copyright.

Papel fabricado con fibras provenientes de bosques gestionados de forma responsable.

© PERONDA GROUP 2023

Av. Manuel Escobedo, 26
12200 Onda (Castellón) Spain
+34 964 602 012

